

Singer 18-35
Singer 18-36

Form 19731
(641)
Printed in U. S. A.

LIST OF PARTS



MACHINES
Nos. 18-35 and 18-36

THE SINGER MANUFACTURING COMPANY

INSTRUCTIONS FOR OILING

To insure easy running and prevent unnecessary wear of the parts which are in movable contact, the machine requires oiling and when in continuous use, it should be oiled at least twice each day.

Use either "Singer Oil for High Speed Sewing Machines" (Cloth and Leather) or "Singer Stainless Oil for High Speed Sewing Machines".

Copyright, U. S. A., 1935, 1939 and 1941
by The Singer Manufacturing Co.
All Rights Reserved for all Countries

INDEX

	Page
Attachments and Accessories.....	22
Bobbin Winders.....	22 and 23
Foot Lifter Parts.....	23
Knee Lifter Parts.....	24
Machine Base.....	24
Machine No. 18-35.....	7
Machine No. 18-36.....	14
Numerical List of Parts.....	25

INSTRUCTIONS FOR ORDERING

In ordering from this list, use ONLY the part NUMBER in the FIRST column.

The number stamped on a Sewing Machine Part is in every case the number of the single part only.

Every combination of parts sent out as such has its specific number, which, although not stamped on the parts, must be used when ordering the combination.

Each number always indicates the SAME PART in whatever list it appears, or for whatever machine.

The letters after some of the numbers indicate the style of finish only, as follows:

A-Hardened, Polished, Nickel Plated and Buffed
A.A-Buffed and Chromium Plated
A.B-Hardened, Polished, Buffed and Chromium Plated
A.C-Brown Baking Enamel Finish
A.D-Gray Baking Enamel Finish
A.E-Hardened, Bright Rumbled and Nickel Plated
A.F-Hardened, Bright Rumbled, Nickel Plated, Bright Rumbled and Chromium Plated
A.G-Alumilite, Plain
A.H-Alumilite, Dyed
A.J-Polished, Nickel Plated and Chromium Plated
A.K-Hardened, Polished, Nickel Plated and Chromium Plated
A.L-Heat Treated for Toughness
B-Polished, Nickel Plated and Buffed
C-Hardened Only
C.R-Hardened and Merlized
D-Polished Only
E-Soft, Not Polished
F-Hardened and Polished
F.J-Hardened, Polished and Nickel Plated
G-Bright Rumbled and Nickel Plated
H-Blued
J-Nickel Plated Only
K-Hardened and Nickel Plated
L-Brass Plated
M-Oxidized
N-Japanned, Dull
P-Japanned, Bright
P.P-Wrinkle Finish
R-Merlized
S-Cadmium Plated
T-Copper Plated
T.A-Hardened, Polished, Copper and Nickel Plated and Buffed
T.B-Copper and Nickel Plated and Polished
T.J-Copper and Nickel Plated Only
T.K-Hardened, Copper and Nickel Plated
T.L-Copper and Brass Plated
T.M-Copper Plated and Oxidized

INSTRUCTIONS FOR ORDERING - Continued

U-Zinc Plated
V-Silver Plated
W-Polished and Nickel Plated
X-Black Oxide, for Iron and Steel
X.C-Hardened and Black Oxide, for Iron or Steel
Y-Black Nickel Plated Only
Z-Chromium Plated
Z.A-Hardened, Polished, Nickel Plated, Buffed and Chromium Plated
Z.B-Polished, Nickel Plated, Buffed and Chromium Plated
Z.C-Hardened and Chromium Plated
Z.D-Polished and Chromium Plated
Z.G-Bright Rumbled, Nickel Plated, Bright Rumbled and Chromium Plated
Z.J-Nickel and Chromium Plated
Z.T-Copper and Chromium Plated

These letters MUST BE USED when they appear in the list; and AFTER the number as in the list.

In this series:

1 to 1500, 50001 to 51500 and 140001 to 142000

are Screw Numbers

1501 to 1800 and 51501 to 51800 are Nut Numbers

1801 to 2000 and 51801 to 52000 are Roller Numbers

2001 to 50000 and 52001 to 140000 and 142001 to

190000 are Sewing Machine Parts, 190001 and upward

are numbers of Electrical Parts.

The figures in the second column refer only to the plates, illustrating the parts, and are NOT TO BE USED in ordering.

Parts marked with an asterisk (*) are furnished only when repairs are made at factory.

When ordering parts which differ as to Gauge (the distance between seams) the Gauge, as well as the Number must be given on order.

LIST OF PARTS COMPLETE
FOR

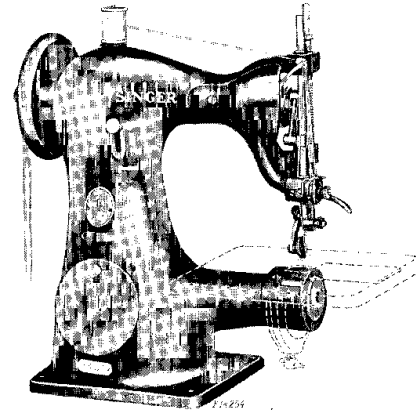

MACHINE No. 18-35

FOR LIGHT LEATHER WORK. DROP FEED AT LEFT
OF NEEDLE. ROLLER PRESSER. SPEED 1800 R. P. M.

No.	Plate	Name
*16291	-----	Arm and Cylinder with 15404 and two 15405.....
16292	-----	Arm Shaft.....
16293	22723	" " 16292 with 65118.....
3005	22723	" " Bushing.....
448AL	22723	" " " Set Screw.....
144D	22723	" " Screw.....
4288	23953	" Side Cover (back).....
51224W	23953	" " " Thumb Screw.....
16106	23953	" " " (front).....
164J	23953	" " " Screw.....
52239	22723	" Spool Pin and Thread Eyelet.....
8879	22723	" " Washer (cloth).....
16267	23953	Balance Wheel (power) disc, 2 3/4 in. pulley, with two 448AL.....
16278	23953	Balance Wheel (stand) disc, 3 in. pulley, for Clamp Stop Motion.....
16298	23953	Balance Wheel (power, disc) "V" belt groove (outside diam. of belt groove 2.9 in.) with two 435AL.....

Genuine Singer Needles should be used
in Singer Machines.
These Needles and their Containers
are marked with the
Company's Trade Mark "SIMANCO." 1

Needles in Containers marked
"For Singer Machines"
are not Singer made needles. 2

No.	Plate	Name
448AL	23953	Balance Wheel Set Screw for 16267 (2)..
435AL	23953	" " " " " 16298 (2)..
256J	23953	Clamp Stop Motion Clamp Screw.....
248K	23953	" " " " Stop Screw.....
2020	23953	" " " " Washer.....
4933	23953	" " " Flanged Bushing with two 462AL.....
2022	----	Clamp Stop Motion Flanged Bushing Pin..
462AL	23953	" " " " Set Screw (2).....
3022	23953	Clamp Stop Motion complete, Nos. 248K, 256J, 2020 and 4933.....
16032	22725	Cloth Plate.....
16143	22725	" " Bracket with 1107C.....
1107C	22725	" " Set Screw.....
389F	22725	" " Screw (2).....
16034	22725	" " Slide.....
3286	22725	" " Spring.....
725J	22725	" " Screw (2).....
6479	22725	Cloth Plate complete, Nos. 3286, 16032, 16034 and two 725J.....
6478	22725	Cloth Plate with Bracket complete, Nos. 6479, 16143 and two 389F.....
4292	22723	Crank Connecting Rod with two 145E.....
145E	22723	" " Cap Screw (2).....
375C	22723	" " Hinge Screw.....
1518J	22723	" " Nut....
16045	22724	Cylinder Oil Tube for oiling Oscillating Shaft.....
16036	23953	Cylinder Side Cover.....
51224W	23953	" " Thumb Screw.....
65118	22723	Feed Cam and Arm Shaft Counterbalance with 435AL.....
435AL	22723	Feed Cam Set Screw.....
52165	22723	" Connecting Link.....
375C	22723	" " Hinge Screw.....
1518J	22723	" " Nut....
16107	23952	" Dog, 10 teeth (16 teeth to the inch) for 16095.....
Note: No. 16107 is sent with this machine unless another Feed Dog is specified on order.		
16172	23952	Feed Dog, 13 teeth (22 teeth to the inch) for 16095.....
16078	23952	Feed Dog, 10 teeth (16 teeth to the inch) for 6492, 16040, 16096, 16097 and 16131
6458	22724	Feed Dog Carrier.....
231C	23952	" Screw.....
3037	22723	" Forked Connection.....
375C	22723	" " Hinge Screw.....
1518J	22723	" " Nut..

No.	Plate	Name
6459	22723	Feed Regulator.....
58E	22723	" " Hinge Screw.....
818D	22723	" " Thumb Screw.....
16037	22724	" Rock Shaft.....
6018	22724	" " Crank with 207F.....
156F	22724	" " Position Screw....
207F	22724	" " Set Screw.....
16294	22723	Needle Bar (hollow).....
3045	22723	" " Connecting Link.....
16220	----	" " " 3045 with 377C, 1518J and 6487.....
377C	22723	Needle Bar Connecting Link Hinge Screw..
1518J	22723	" " " " Nut
6487	22723	" " Stud with 155C....
155C	22723	" " Set Screw....
290E	22723	" Screw Bushing (2).....
4302	22723	" Thread Guide.....
235J	22723	" " Screw.....
4303	22723	" Clamp with 808F.....
808F	22723	" Screw.....
6461	22724	Oscillating Rock Shaft with 4784.....
16176	22724	Oscillating Rock Shaft complete, Nos. 6461 and 16212.....
6489	22724	Oscillating Rock Shaft Hinge Pin.....
16212	----	" " " " 6489 with 1513J.....
1513J	22724	Oscillating Rock Shaft Hinge Pin Nut....
4784	22724	" " Oil Pad.....
16039	22724	" Shaft.....
6024	22724	" Crank with 1813 and two 462AL.....
1813	22724	Oscillating Shaft Crank Roller and Stud.
462AL	22724	" " Set Screw for 6024 (2).....
3054	22723	Presser Bar.....
6464	22723	" Lifter.....
77F	22723	" Screw.....
6465	22723	" Washer.....
16194	22723	" Lifting Bracket with 175J and two 457K.....
16195	----	Presser Bar Lifting Bracket 16194 with 16196 and two 335J.....
175J	22723	Presser Bar Lifting Bracket Adjusting Screw.....
6469	22723	Presser Bar Lifting Bracket Guide.....
175J	22723	" " " " Screw (2).....
457K	22723	Presser Bar Lifting Bracket Set Screw (2).....
16196	22723	Presser Bar Lifting Bracket Wearing Plate.....

No.	Plate	Name
335J	22723	Presser Bar Lifting Bracket Wearing Plate Screw (2).....
290E	22723	Presser Bar Screw Bushing.....
5459	22723	" " Spring (light) .047 in. wire
6466	-----	" " " (medium) .055 in. wire
6467	-----	" " " (heavy) .063 in. wire
2070	22723	" " " Washer.....
2180	23952	" " Foot.....
190J	23952	" " Screw.....
262J	22723	Pressure Regulating Thumb Screw.....
1868	23954	Roller, 7/8 in. diam., 9/64 in. face, coarse, with 652D and 1528J, for 2196
1841	23954	Roller, 7/8 in. diam., 9/64 in. face, fine, with 652D and 1528J, for 2197.
1839	23954	Roller, 1 1/4 in. diam., 9/64 in. face, coarse, with 386D and 1528J, for 16099.....
1869	23954	Roller, 1 1/4 in. diam., 9/64 in. face, fine, with 386D and 1528J, for 16100
1897	23954	Roller, 1 1/4 in. diam., 3/16 in. face, coarse, with 386D and 1528J, for 16225.....
1898	23967	Roller, 1 1/4 in. diam., 3/16 in. face, fine, with 386D and 1528J, for 16226
1923	23967	Roller, 1 1/4 in. diam., 1/8 in. face, coarse, with 652D and 1528J, for 16228.....
51832	23967	Roller, 1 1/4 in. diam., 7/32 in. face, coarse (ball bearing) complete for 16233, Nos. 1528J, 1766C, 50553C and twenty-four 16232.....
51841	23967	Roller, 1 1/4 in. diam., 5/32 in. face, coarse (ball bearing) complete for 16236, Nos. 1528J, 1766C, 50553C and twenty-four 16232.....
2203	23954	Roller Arm for 2196 and 2197.....
16098	23954	" " " 16099, 16100, 16225, 16226 and 16228.....
16230	23967	Roller Arm for 16233 and 16236.....
440F	23954	" " Adjusting Screw.....
15446	-----	" " " 440F with 1547J
1547J	23954	" " " Nut.....
2206	23954	" " Bracket for 2196 and 2197....
4282	23954	" " " 16099, 16100, 16225, 16226, 16228, 16233 and 16236.....
2205	23954	Roller Arm Lock Spring.....
176J	23954	" " " Screw.....
1549J	23954	" " " Nut.....
316F	23954	" " Screw Center (2).....
15444	-----	" " " 316F with 1547J (2).....

No.	Plate	Name
1547J	23954	Roller Arm Screw Center Nut (2).....
16232	23967	" " Ball, size 3/32 in.....
1766C	23967	" " Retaining Nut.....
2196	23954	Roller Presser complete, 7/8 in. diam., 9/64 in. face, coarse roller, Nos. 176J, 1549J, 1868, 2203, 2205, 2206, 15446 and two 15444.....
2197	23954	Roller Presser complete, 7/8 in. diam., 9/64 in. face, fine roller, Nos. 176J, 1549J, 1841, 2203, 2205, 2206, 15446 and two 15444.....
16099	23954	Roller Presser complete, 1 1/4 in. diam., 9/64 in. face, coarse roller, Nos. 176J, 1549J, 1839, 2205, 4282, 15446, 16098 and two 15444.....
16100	23954	Roller Presser complete, 1 1/4 in. diam., 9/64 in. face, fine roller, Nos. 176J, 1549J, 1869, 2205, 4282, 15446, 16098 and two 15444.....
16225	23954	Roller Presser complete, 1 1/4 in. diam., 3/16 in. face, coarse roller, Nos. 176J, 1549J, 1897, 2205, 4282, 15446, 16098 and two 15444.....
16226	23967	Roller Presser complete, 1 1/4 in. diam., 3/16 in. face, fine roller, Nos. 176J, 1549J, 1898, 2205, 4282, 15446, 16098 and two 15444.....
16228	23967	Roller Presser complete, 1 1/4 in. diam., 1/8 in. face, coarse roller, Nos. 176J, 1549J, 1923, 2205, 4282, 15446, 16098 and two 15444.....
16233	23967	Roller Presser (ball bearing) complete, 1 1/4 in. diam., 7/32 in. face, coarse roller, Nos. 176J, 1549J, 2205, 4282, 15446, 16230, 51832 and two 15444...
16236	23967	Roller Presser (ball bearing) complete, 1 1/4 in. diam., 5/32 in. face, coarse roller, Nos. 176J, 1549J, 2205, 4282, 15446, 16230, 51841 and two 15444...
190J	-----	Roller Presser Screw.....
652D	23954	" " Screw for 1841, 1868 and 1923....
386D	23954	" " " 1839, 1869, 1897 and 1898
50553C	23967	" " " 51832 and 51841.....
1528J	23954	" " Nut.....
2073	23951	Shuttle Bobbin.....
2211	23951	" " Retaining Spring.....
2212	23951	" " " Rivet (2)
6058	23951	" " Body with 398E, 2082, 2084, 2211 and two 2212.....
44001	23951	Shuttle Cover with 112E, 466H, 2078, 2080, 2086 and 2090.....

PARTS FOR MACHINE No. 18-35

No.	Plate	Name
2076	23951	Shuttle Cover Hinge Pin.....
2078	23951	" Delivery Eye Thread Guard.....
2080	23951	" " " Rivet.
2082	23951	" Main Spring.....
398E	-----	" " " Screw.....
2084	-----	" " " Steady Pin.....
466H	23951	" Tension Regulating Screw.....
2086	23951	" " Spring.....
2090	23951	" " " Plate.....
112E	23951	" " " Screw.....
6028	23951	Shuttle (high point) complete, Nos.2073, 2076, 6058 and 44001.....
16175	22724	Shuttle Driver and Feed Lifting Cam.....
2049	22724	" " " " " Pin
16174	23951	" Race.....
16227	-----	" " 16174 with 6471 and two 102J
6900	23951	" " Cap.....
6471	23951	Shuttle Race Cap complete, Nos.6472,6900 and two 725J.....
6472	23951	Shuttle Race Cap Latch.....
725J	23951	" " " Screw (2).....
102J	23951	" " " Screw (2).....
50037F	23951	" " " Screw (4).....
2102	22723	Tension Disc (2).....
1560C	22723	" Regulating Thumb Nut.....
16279	22723	" Releaser.....
16240	22723	" " Collar with 7393 and two 1253AL.....
7393	22723	Tension Releaser Collar Pin.....
1253AL	22723	" " " Set Screw (2)..
50116K	22723	" " " Screw.....
600C	22723	" " " Screw Stud.....
16202	-----	" " " 600C with 1560C.....
175D	22723	" " " Set Screw.....
2103	22723	" Spring.....
16022	22723	" Thread Guard.....
219J	22723	" " " Screw.....
16204	22723	Tension complete, Nos. 2103, 16202 and two 2102.....
2112	22723	Thread Retaining Disc with 2113.....
2113	22723	" " " Steady Pin.....
2114	22723	" " " Spring.....
2115	22723	" " " Stud.....
460AL	22723	" " " Set Screw.....
2111	22723	Thread Retainer Guide complete, Nos. 2112, 2114 and 2115.....
16270	22723	Thread Take-up Cam with 446AL.....
3012	22723	" " " Pin.....
446AL	22723	" " " Set Screw.....
16041	22723	" " " Lever with 1547J and 1915

PARTS FOR MACHINE No. 18-35

No.	Plate	Name
16179	22723	Thread Take-up Lever 16041 with 76F.....
76F	22723	" " " Hinge Screw.....
1915	22723	" " " Roller and Screw Stud.....
1547J	22723	Thread Take-up Lever Roller and Screw Stud Nut.....
6768	22723	Thread Take-up Spring.....
6477	22723	" " " Regulator Plate...
233J	22723	" " " " Ad- justing Screw.....
16095	23952	Throat Plate (fluted) needle hole drilled for No. 1 needle to locate close to the side nearest the feed- way, for 16107 and 16172.....
Note: No. 16095 is sent with this machine unless another Throat Plate is specified on order.		
16096	23952	Throat Plate (not fluted) needle hole drilled for No. 2 needle to locate close to the side nearest the feed- way, for 16078.....
16131	23952	Throat Plate (fluted) needle hole drilled for No. 2 needle to locate close to the side nearest the feed- way, for 16078.....
6492	23952	Throat Plate (fluted) large needle hole, for 16078.....
16097	23952	Throat Plate (fluted) small needle hole, for 16078.....
16040	23952	Throat Plate (fluted) for 16078.....
399D	23952	" " " Screw (2).....
16077	23962	Drip Pan.....
*15404	-----	Trade Mark.....
15405	-----	" " Rivet (2).....

LIST OF PARTS COMPLETE
FOR

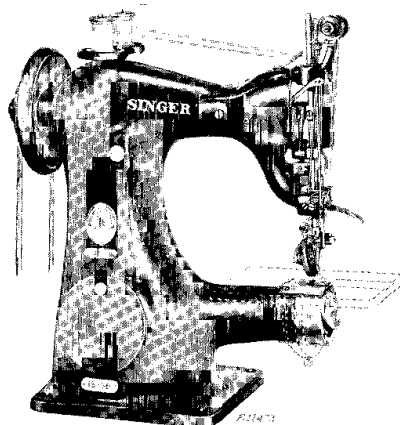

MACHINE No. 18-36

For Shoe Vamping and Leather Work. Two needles, two shuttles. Gauges from $\frac{1}{32}$ inch to $\frac{1}{4}$ inch, in steps of $\frac{1}{32}$ inch. The standard gauge is $\frac{1}{32}$ inch. Maximum stitch $6\frac{1}{3}$ to the inch. Roller presser. Speed 1800 R. P. M.

No.	Plate	Name
*16295	-----	Arm and Cylinder with 15404 and two 15405.....
16292	-----	Arm Shaft.....
16293	23955	" " 16292 with 65118.....
3005	23955	" " Bushing.....
448AL	23955	" " " Set Screw.....
144D	23955	" " Screw.....
4288	23968	" Side Cover (back).....
51224W	23968	" " " Thumb Screw.....
16106	23968	" " " (front).....
164J	23968	" " " Screw.....
2415	23968	" Spool Bracket.....
15063	23968	" " " 2415 with two 52239....
145J	23968	" " " Screw.....
52239	23968	" " " Spool Pin and Thread
		Eyelet (2).....
11241	23968	Arm Spool Bracket Spool Pin Washer (cloth) (2).....

No.	Plate	Name
16267	23968	Balance Wheel (power) disc, 2 $\frac{3}{4}$ in. pulley, with two 448AL.....
16278	23968	Balance Wheel (stand) disc, 3 in. pulley, for Clamp Stop Motion.....
16298	23968	Balance Wheel (power, disc) "V" belt groove (outside diam. of belt groove 2.9 in.) with two 435AL.....
448AL	23968	Balance Wheel Set Screw for 16267 (2)..
435AL	23968	" " " " " 16298 (2)..
256J	23968	Clamp Stop Motion Clamp Screw.....
248K	23968	" " " " Stop Screw.....
2020	23968	" " " " Washer.....
4933	23968	" " " Flanged Bushing with two 462AL.....
2022	-----	Clamp Stop Motion Flanged Bushing Pin...
462AL	23968	" " " " Set Screw (2).....
3022	23968	Clamp Stop Motion complete, Nos. 248K, 256J, 2020 and 4933.....
6716	23959	Cloth Plate.....
6719	23959	" " Bracket with 345C.....
345C	23959	" " " Set Screw.....
389F	23959	" " Screw (2).....
6718	23959	" " Slide.....
3286	23959	" " " Spring.....
725J	23959	" " " Screw (2).....
6717	23959	Cloth Plate complete, Nos. 3286, 6716, 6718 and two 725J.....
6702	23959	Cloth Plate with Bracket complete, Nos. 6717, 6719 and two 389F.....
4292	23955	Crank Connecting Rod with two 145E.....
145E	23955	" " " Cap Screw (2).....
375C	23955	" " " Hinge Screw.....
1518J	23955	" " " " Nut....
16045	23956	Cylinder Oil Tube for oiling Oscillating Shaft.....
16036	23968	Cylinder Side Cover.....
51224W	23968	" " " Thumb Screw.....
65118	23955	Feed Cam and Arm Shaft Counterbalance with 435AL.....
435AL	23955	Feed Cam Set Screw.....
52165	23955	" Connecting Link.....
375C	23955	" " " Hinge Screw.....
1518J	23955	" " " " Nut....
16018	23960	" Dog, 8 teeth (14 teeth to the inch) for $\frac{1}{32}$ in. to $\frac{5}{64}$ in. gauges, for 16153.....
6677	23960	Feed Dog, 8 teeth (14 teeth to the inch) for $\frac{3}{32}$ in. to $\frac{1}{4}$ in. gauges, for 16153.....

No.	Plate	Name
6458	23956	Feed Dog Carrier.....
231C	23960	" " Screw.....
3037	23955	" Forked Connection.....
375C	23955	" " " Hinge Screw.....
1518J	23955	" " " " " Nut..
6459	23955	" Regulator.....
58E	23955	" " Hinge Screw.....
818D	23955	" " Thumb Screw.....
16075	23956	" Rock Shaft.....
6018	23956	" " Crank with 207F.....
156F	23956	" " " " Position Screw....
207F	23956	" " " " Set Screw.....
16275	23955	Needle Bar (hollow).....
16276	-----	" " 16275 with 2273 and 4345, for 1/32 in. to 5/64 in. gauges.....
16277	-----	Needle Bar 16275 with 2273 and 6524, for 3/32 in. to 1/4 in. gauges.....
3045	23955	Needle Bar Connecting Link.....
16220	-----	" " " " 3045 with 377C, 1518J and 6487.....
377C	23955	Needle Bar Connecting Link Hinge Screw..
1518J	23955	" " " " " Nut
6487	23955	" " " " Stud with 155C....
155C	23955	" " " " Set Screw.....
3214	23955	" " Guide with 400C and 453AL....
400C	23955	" " " Adjusting Screw.....
453AL	23955	" " " Set Screw.....
290E	23955	" " Screw Bushing (2).....
4345	23955	" Clamp with two 336F, for 1/32 in. to 5/64 in. gauges.....
6524	23955	Needle Clamp with two 50014F, for 3/32 in. to 1/4 in. gauges.....
2273	-----	Needle Clamp Pin.....
336F	23955	" Set Screw for 4345 (2).....
50014F	23955	" " " " 6524 (2).....
*16111	23956	Oscillating Rock Shaft.....
16112	23956	Oscillating Rock Shaft complete, Nos. 4784, 16111 and 16212.....
6489	23956	Oscillating Rock Shaft Hinge Pin.....
16212	-----	" " " " " 6489 with 1513J.....
1513J	23956	Oscillating Rock Shaft Hinge Pin Nut....
4784	23956	" " " Oil Pad.....
16114	23956	" Shaft.....
16115	23956	" Crank.....
16116	-----	Oscillating Shaft Crank complete, Nos. 1518J, 16115, 19390 and two 462AL....
462AL	23956	Oscillating Shaft Crank Set Screw (2)..
19389	23956	" " " Slide Block.....
226J	23956	" " " " Cap Screw.....

No.	Plate	Name
12424	23956	Oscillating Shaft Crank Slide Block Cap Screw Washer.....
969C	23956	Oscillating Shaft Crank Slide Block Screw Stud.....
1518J	23956	Oscillating Shaft Crank Slide Block Screw Stud Nut.....
19390	-----	Oscillating Shaft Crank Slide Block com- plete, Nos. 226J, 969C, 12424 and 19389
16145	23955	Presser Bar (hollow).....
6464	23955	" " Lifter.....
77F	23955	" " " Screw.....
6465	23955	" " " Washer.....
16197	23955	" " Lifting Bracket with 175J and two 457K.....
16198	-----	Presser Bar Lifting Bracket 16197 with 16196 and two 335J.....
175J	23955	Presser Bar Lifting Bracket Adjusting Screw.....
6469	23955	Presser Bar Lifting Bracket Guide.....
175J	23955	" " " " " Screw (2).....
457K	23955	Presser Bar Lifting Bracket Set Screw (2).....
16196	23955	Presser Bar Lifting Bracket Wearing Plate.....
335J	23955	Presser Bar Lifting Bracket Wearing Plate Screw (2).....
921E	23955	Presser Bar Screw Bushing.....
16156	23955	" " Spring (light) .065 wire....
11170	23955	" " " Washer.....
16148	23955	" " Stop Collar with 1019C.....
1019C	23955	" " " " Set Screw.....
688J	23955	Pressure Regulating Thumb Screw.....
1958	23960	Roller, 1 1/2 in. diam., 3/16 in. face, coarse, with 1261D and 1528J, for 16071 and 16082.....
1875	23960	Roller, 1 1/2 in. diam., 7/32 in. face, coarse, with 634D and 1528J, for 16014 and 16017.....
51834	23960	Roller, 1 1/2 in. diam., 3/16 in. face, coarse (ball bearing) complete for 16234 and 16235, Nos. 1528J, 1768C, 50553C and twenty-four 16232.....
16015	23960	Roller Arm for 16017 and 16071.....
6535	23960	" " " 16014 and 16082.....
16231	23960	" " " 16234 and 16235.....
440F	23960	" " Adjusting Screw.....
15446	-----	" " " " 440F with 1547J
1547J	23960	" " " " Nut.....
19200	23960	" " Bracket for 16017, 16071 and 16235.....

No.	Plate	Name
4785	23960	Roller Arm Bracket for 16014, 16082 and 16234.....
7556	23960	Roller Arm Lock Spring.....
176J	23960	" " " " " Screw.....
1549J	23960	" " " " " Nut.....
316F	23960	" " " " " Screw Center (2).....
15444	-----	" " " " " 316F with 1547J (2).....
1547J	23960	Roller Arm Screw Center Nut (2).....
16232	23960	" Ball, size 3/32 in.....
1766C	23960	" " Retaining Nut.....
16080	23960	" Needle Guard (flat) for 16082 and 16234.....
16010	23960	Roller Needle Guard (flat) for 16014....
207F	-----	" " " " " Screw.....
16016	23960	" " " " (round) for 16017, 16071 and 16235.....
16013	23960	Roller Needle Guard (round) for 16014....
16081	23960	" " " " " 16082 and 16234.....
16138	-----	Roller Needle Guard (round) with 242J and 16139, for 16014.....
16139	-----	Roller Needle Guard (round) Edge Guide for 16138.....
242J	-----	Roller Needle Guard (round) Edge Guide Screw.....
171F	23960	Roller Needle Guard (round) Set Screw...
16082	23960	Roller Presser complete, 1 1/2 in.diam., 3/16 in. face, coarse roller, for 1/32 in. to 5/64 in. gauges, Nos. 171F,176J,207F,1549J,1958,4785,6535,7556,15446,16080,16081 and two 15444
16014	23960	Roller Presser complete, 1 1/2 in. diam., 7/32 in. face, coarse roller, for 1/32 in. to 1/16 in. gauges, Nos. 171F,176J,207F,1549J,1875,4785,6535,7556,15446,16010,16013 and two 15444
16071	23960	Roller Presser complete, 1 1/2 in.diam., 3/16 in. face, coarse roller, for 3/32 in. to 1/4 in. gauges,Nos.171F,176J,1549J,1958,7556,15446,16015,16016,19200 and two 15444.....
16017	23960	Roller Presser complete, 1 1/2 in.diam., 7/32 in. face, coarse roller, for 3/32 in. to 1/4 in. gauges,Nos.171F,176J,1549J,1875,7556,15446,16015,16016,19200 and two 15444.....

No.	Plate	Name
16234	23960	Roller Presser (ball bearing) complete, 1 1/2 in.diam., 3/16 in.face, coarse roller, for 1/32 in. to 5/64 in. gauges, Nos. 171F,176J,207F,1549J,4785,7556,15446,16080,16081,16231,51834 and two 15444.....
16235	23960	Roller Presser (ball bearing) complete, 1 1/2 in. diam.,3/16 in.face, coarse roller, for 3/32 in. to 1/4 in. gauges, Nos. 171F, 176J, 1549J,7556,15446, 16016, 16231, 19200, 51834 and two 15444.....
190J	23960	Roller Presser Screw.....
634D	23960	" Screw for 1875.....
1261D	23960	" " " 1958.....
50553C	23960	" " " 51834.....
1528J	23960	" " Nut.....
2210	23957	Shuttle (inside) Bobbin.....
3230	23957	" " " Retaining Spring
2212	23957	" " " " " Rivet (2).....
3235	23957	Shuttle (inside) Body with 398E, 2084, 3230, 3240 and two 2212.....
16205	23957	Shuttle (inside) Cover.....
2076	23957	" " " Hinge Pin.....
2078	23957	" " " Delivery Eye Thread Guard.....
2080	23957	Shuttle (inside) Delivery Eye Thread Guard Rivet.....
3240	23957	Shuttle (inside) Main Spring.....
398E	-----	" " " " " Screw.....
2084	-----	" " " " " Steady Pin.....
466H	23957	" " " Tension Regulating Screw
2086	23957	" " " Spring.....
2090	23957	" " " " " Plate....
112E	23957	" " " " " Screw
16206	23957	Shuttle (inside) closed eye, complete, for 1/32 in. to 1/4 in. gauges, Nos. 112E,466H,2076,2078,2080,2086,2090,2210,3235 and 16205.....
2210	23957	Shuttle (outside) Bobbin.....
3230	23957	" " " Retaining Spring
2212	23957	" " " " " Rivet (2).....
3232	23957	Shuttle (outside) Body with 398E, 2084, 3230, 3239 and two 2212, for 16209..
3383	23958	Shuttle (outside) Body with 398E, 2084, 3230, 3239 and two 2212, for 16208..
16207	23957	Shuttle (outside) Cover.....
2076	23957	" " " Hinge Pin.....

No.	Plate	Name
3238	23957	Shuttle (outside) Delivery Eye Thread Guard.....
2080	23957	Shuttle (outside) Delivery Eye Thread Guard Rivet.....
3239	23957	Shuttle (outside) Main Spring.....
398E	----	" " " " Screw.....
2084	----	" " " " Steady Pin
466H	23957	" " Tension Regulating Screw.....
3241	23957	Shuttle (outside) Tension Spring.....
3242	23957	" " " " Plate..
112E	23957	" " " " " Screw.....
16209	23957	Shuttle (outside) closed eye complete, for 1/32 in. to 5/64 in. gauges, Nos. 112E, 466H, 2076, 2080, 2210, 3232, 3238, 3241, 3242 and 16207.....
16208	23958	Shuttle (outside) closed eye complete, for 3/32 in. to 1/4 in. gauges, Nos. 112E, 466H, 2076, 2080, 2210, 3238, 3241, 3242, 3383 and 16207.....
16213	23956	Shuttle Driver and Feed Lifting Cam.....
2049	23956	" " " " " Pin.
16166	23958	" Race Body (two pieces) with either 813D, 814D or 815D, for 6746.
16238	23957	Shuttle Race Body (two pieces) with 813D, for 16239.....
16103	23968	Shuttle Race Cap.....
102J	23968	" " " Screw.....
813D	23957	" " Hinge Screw, for 1/32 in. to 1/8 in. gauges.....
814D	23958	Shuttle Race Hinge Screw, for 9/64 in. to 11/64 in. gauges.....
815D	23958	Shuttle Race Hinge Screw, for 3/16 in. to 1/4 in. gauges.....
6709	23957	Shuttle Race Lock Pin.....
Note: When ordering No. 6709, state gauge of Shuttle Race for which it is required.		
16101	23957	Shuttle Race Lock Pin Bushing.....
6758	23957	" " " " Spring.....
102J	23957	" " " " Screw.....
6746	23958	Shuttle Race complete, for 3/32 in. to 1/4 in. gauges, Nos. 6709, 6758, 16166 and two 102J.....
16239	23957	Shuttle Race complete, for 1/32 in. to 5/64 in. gauges, Nos. 6709, 6758, 16238 and two 102J.....
738D	23957	Shuttle Race Screw (2).....
16136	23955	Tension and Needle Bar Guide Bracket....

No.	Plate	Name
16137	23955	Tension and Needle Bar Guide Bracket complete, Nos. 16136, two each 2103, 33929 and four 2102.....
190J	23955	Tension and Needle Bar Guide Bracket Screw (2).....
2102	23955	Tension Disc (4).....
1560C	23955	" Regulating Thumb Nut.....
6600	23955	" Releaser.....
16149	23955	" " Bracket with two 465C..
465C	23955	" " " Set Screw (2).
207F	23955	" " Screw.....
637C	23955	" Screw Stud.....
33929	----	" " " 637C with 1560C.....
2103	23955	" Spring (2).....
2413	23955	" Thread Eyelet (double).....
330D	23955	" " " Screw.....
16270	23955	" Take-up Cam with 446AL.....
3012	23955	" " " Pin.....
446AL	23955	" " " Set Screw.....
6704	23955	" " Lever with 1819.....
16181	23955	" " " 6704 with 76F.....
76F	23955	" " " Hinge Screw.....
1819	23955	" " " Roller and Stud...
2410	23955	" " " Roller.....
86D	23955	" " " Screw.....
2411	23955	" " " Stud.....
175F	23955	" " " Set Screw...
6603	23955	" " " Spring.....
6477	23955	Thread Take-up Spring Regulator Plate...
233J	23955	" " " " " Ad-justing Screw.....
6602	23955	Thread Take-up Spring Thread Guard and Thread Eyelet.....
219D	23955	Thread Take-up Spring Thread Guard and Thread Eyelet Screw.....
16151	23960	Throat Plate Body.....
16152	23960	" " Needle Plate.....
228D	23960	" " " " Screw.....
16153	23960	Throat Plate complete for 16018, for 1/32 in. to 5/64 in. gauges, and for 6677, for 3/32 in. to 1/4 in. gauges, Nos. 228D, 16151 and 16152.....
691D	23960	Throat Plate Screw (2).....
16077	23962	Drip Pan.....
*15404	----	Trade Mark.....
15405	----	" " Rivet (2).....

ATTACHMENTS AND ACCESSORIES

No.	Plate	Name
51072E	23963	Machine Bolt with 51581E, to secure machine to table.....
51581E	23963	Machine Bolt Nut.....
6065	23963	" " " Washer.....
120342	23963	Oiler (copper plated) with 120343.....
120343	23963	" Spout, 3 1/2 in. long.....
26026	23963	Screw Driver (machine).....
26485	23963	" " (shuttle tension).....
8908	23963	Wrench for 1620.....
8909	23963	" " 1513 and 1518.....
4822	23963	" " 1528, 1547 and 1549.....

BOBBIN WINDERS

BOBBIN WINDER (SWINGING AUTOMATIC, LEFT HAND) FOR ROUND BELT

No.	Plate	Name
16271	23961	Base.....
27321	23961	Frame.....
50356D	23961	" Hinge Screw.....
1620J	23961	" " " Nut.....
27322	23961	" Spring.....
27541	23961	Pulley.....
27305	23961	Spindle.....
27306	23961	Spool Pin.....
27307	23961	" Stand.....
27308	23961	Spool Stand complete, Nos. 418E, 1562J, 2106, 10141, 11241, 27306, 27307 and two each 2455 and wood screws 1 in. No. 10.....
11241	23961	Spool Washer (cloth).....
27326	23961	Stop Latch.....
35D	23961	" " Hinge Screw.....
2455	23961	Tension Disc (2).....
1562J	23961	" Regulating Thumb Nut.....
418E	23961	" Screw Stud.....
10141	23961	" Spring.....
2106	23961	" Thread Guide.....

BOBBIN WINDER

23

No.	Plate	Name
16272	23961	Bobbin Winder, Nos. 35D, 1620J, 16271, 27305, 27321, 27322, 27326, 27541, 50356D and two wood screws 1 in. No. 7.....
16273	23961	Bobbin Winder (swinging automatic, left hand) complete, Nos. 16272 and 27308

BOBBIN WINDER

(SWINGING AUTOMATIC, LEFT HAND) FOR "V" BELT

NOTE: THIS BOBBIN WINDER IS THE SAME AS THE NO. 16273 WITH THE FOLLOWING EXCEPTIONS:

No.	Plate	Name
150785	23961	Pulley, in place of 27541.....
150868	23961	Bobbin Winder, Nos. 35D, 1620J, 16271, 27305, 27321, 27322, 27326, 50356D, 150785 and two wood screws 1 in. No. 7, in place of 16272.....
150869	23961	Bobbin Winder (swinging automatic, left hand) complete, Nos. 27308 and 150868

FOOT LIFTER PARTS

No.	Plate	Name
6439	23966	Chain, 36 in. to 45 in., with 56864 and 56865.....
Note: When ordering No. 6439, give length required.		
4879	23966	Chain Connecting Link.....
56864	23966	" Hook (large).....
56865	23966	" " (small).....
16042	23966	Lifting Lever.....
802D	23966	" " Hinge Screw.....
16043	23966	" " Spring.....
4881	23966	Treadle.....
4882	23966	" Shaft.....
4883	23966	" Spring.....
4884	23966	" Stand.....

FOOT LIFTER PARTS

No.	Plate	Name
4885	23966	Treadle complete, Nos. 4879, 4881 to 4884 and two wood screws 1 in. No. 16....
16054	23966	Foot Lifter complete, Nos. 802D, 4885, 6439, 16042 and 16043.....

KNEE LIFTER PARTS

No.	Plate	Name
16042	23964	Lifting Lever.....
802D	23964	" " Hinge Screw.....
16043	23964	" " Spring.....
6703	23964	Pitman, length 14 1/8 in., for 16044....
7898	23965	" " 19 in., for 16155.....
7124	23964	Rock Shaft.....
2764	23964	" " Hanger (back) with two wood screws 1 in. No. 10.....
16128	23964	Rock Shaft Hanger (front) with two wood screws 1 in. No. 10.....
16646	23964	Rock Shaft Knee Arm.....
16647	-----	Rock Shaft Knee Arm complete, Nos. 2766, 2767 and 16646.....
2766	23964	Rock Shaft Knee Arm Hub with 356C.....
356C	23964	" " " " Set Screw.....
2767	23964	" " " Plate with 356C.....
356C	23964	" " " " Set Screw.....
6337	23964	" " Lifting Bracket with two 356C
6338	23964	" " " " Hook.....
356C	23964	" " " " Set Screw
356C	23964	" " " " Set Screw....
2770	23964	" " Stop Dog with 140219C (2)...
140219C	23964	" " " " Set Screw (2).....
16129	23964	Rock Shaft complete, Nos. 2764, 6337, 6338, 7124, 16128, 16647 and two 2770.....
16044	23964	Knee Lifter complete (Power Table or Stand) Nos. 802D, 8703, 16042, 16043 and 16129.....
16155	23965	Knee Lifter complete, for Machine on Base, Nos. 802D, 7898, 16042, 16043 and 16129.....

MACHINE BASE

No.	Plate	Name
16031	23962	Machine Base with four each 121E and wood screws 1 1/4 in. No. 12.....
121E	23962	Machine Screw, to secure machine to base (4).....

NUMERICAL LIST OF PARTS

No.	Plate	Name
35D	23961	Bobbin Winder Stop Latch Hinge Screw for 16272 and 150868.....
58E	22723	Feed Regulator Hinge Screw.....
76F	22723	Thread Take-up Lever Hinge Screw for 16179 and 16181.....
77F	22723	Presser Bar Lifter Screw.....
86D	23955	Tension Take-up Roller Screw for 18-36 Machine.....
102J	23951	Shuttle Race Cap Screw for 6746, 16227 and 16239.....
102J	23957	Shuttle Race Lock Pin Spring Screw for 6746 and 16239.....
112E	23951	Shuttle Tension Spring Plate Screw for 44001.....
112E	23957	Shuttle (inside) Tension Spring Plate Screw for 16206.....
112E	23957	Shuttle (outside) Tension Spring Plate Screw for 16208 and 16209.....
121E	23962	Machine Screw, to secure machine to base, for 16031 (4).....
144D	22723	Arm Shaft Screw.....
145J	23968	Arm Spool Bracket Screw for 18-36 Machine.....
145E	22723	Crank Connecting Rod Cap Screw for 4292 (2).....
155C	22723	Needle Bar Connecting Stud Set Screw for 6487.....
156F	22724	Feed Rock Shaft Crank Position Screw....
164J	23953	Arm Side Cover (front) Screw.....
171F	23960	Roller Needle Guard (round) Set Screw for 16014, 16017, 16071, 16082, 16234 and 16235.....
175J	22723	Presser Bar Lifting Bracket Adjusting Screw for 16194 and 16197.....
175J	22723	Presser Bar Lifting Bracket Guide Screw (2).....
175D	22723	Tension Screw Stud Set Screw for 18-35 Machine.....
175F	23955	Tension Take-up Roller Stud Set Screw for 18-36 Machine.....
176J	23954	Roller Arm Lock Spring Screw for 2196, 2197, 16014, 16017, 16071, 16082, 16099, 16100, 16225, 16226, 16228 and 16233 to 16236.....
190J	23952	Presser Foot Screw for 18-35 Machine....
190J	23960	Roller Presser Screw.....

NUMERICAL LIST OF PARTS

No.	Plate	Name
190J	23955	Tension and Needle Bar Guide Bracket Screw for 18-36 Machine (2).....
207F	22724	Feed Rock Shaft Crank Set Screw for
207F	-----	Roller Needle Guard (flat) Screw for 16014, 16082 and 16234.....
207F	23955	Tension Releaser Screw for 18-36 Machine
219J	22723	" Thread Guard Screw for 18-35 Machine.....
219D	23955	Thread Take-up Spring Thread Guard and Thread Eyelet Screw for 18-36 Machine.....
226J	23956	Oscillating Shaft Crank Slide Block Cap Screw for 19390.....
228D	23960	Throat Plate Needle Plate Screw for 16153.....
231C	23952	Feed Dog Screw.....
233J	22723	Needle Bar Thread Guide Screw for 18-35 Machine.....
233J	22723	Thread Take-up Spring Regulator Plate Adjusting Screw.....
242J	-----	Roller Needle Guard (round) Edge Guide Screw for 16138.....
248K	23953	Clamp Stop Motion Clamp Stop Screw for 3022.....
256J	23953	Clamp Stop Motion Clamp Screw for 3022..
262J	22723	Pressure Regulating Thumb Screw for 18-35 Machine.....
290E	22723	Needle Bar Screw Bushing (2).....
290E	22723	Presser Bar Screw Bushing for 18-35 Machine.....
316F	23954	Roller Arm Screw Center for 15444 (2)..
330D	23955	Tension Thread Eyelet Screw for 18-36 Machine.....
335J	22723	Presser Bar Lifting Bracket Wearing Plate Screw for 16195 and 16198 (2)
336F	23955	Needle Set Screw for 4345 (2).....
345C	23959	Cloth Plate Bracket Set Screw for 6719..
356C	23964	Rock Shaft Knee Arm Hub Set Screw for 2766.....
356C	23964	Rock Shaft Knee Plate Set Screw for 2767
356C	23964	" " Lifting Bracket Hook Set Screw for 6337.....
356C	23964	Rock Shaft Lifting Bracket Set Screw for 6337.....
375C	22723	Crank Connecting Rod Hinge Screw.....
375C	22723	Feed Connecting Link Hinge Screw.....
375C	22723	" Forked Connection Hinge Screw.....
377C	22723	Needle Bar Connecting Link Hinge Screw for 16220.....
386D	23954	Roller Screw for 1839,1869,1897 and 1898

NUMERICAL LIST OF PARTS

No.	Plate	Name
389F	22725	Cloth Plate Screw for 6479 and 6702 (2)
398E	-----	Shuttle Main Spring Screw for 6058.....
398E	-----	" (inside) Main Spring Screw for 3235.....
398E	-----	Shuttle (outside) Main Spring Screw for 3232 and 3383.....
399D	23952	Throat Plate Screw for 18-35 Machine (2)
400C	23955	Needle Bar Guide Adjusting Screw for 3214.....
418E	23961	Bobbin Winder Tension Screw Stud for 27308.....
435AL	23953	Balance Wheel Set Screw for 16298.....
435AL	22723	Feed Cam Set Screw for 65118.....
440F	23954	Roller Arm Adjusting Screw for 15446....
446AL	22723	Thread Take-up Cam Set Screw for 16270..
448AL	22723	Arm Shaft Bushing Set Screw.....
448AL	23953	Balance Wheel Set Screw for 16267 (2)..
453AL	23955	Needle Bar Guide Set Screw for 3214.....
457K	22723	Presser Bar Lifting Bracket Set Screw for 16194 and 16197 (2).....
460AL	22723	Thread Retaining Stud Set Screw for 18-35 Machine.....
462AL	23953	Clamp Stop Motion Flanged Bushing Set Screw for 4933 (2).....
462AL	22724	Oscillating Shaft Crank Set Screw for 6024 and 16116 (2).....
465C	23955	Tension Releaser Bracket Set Screw for 16149 (2).....
466H	23951	Shuttle Tension Regulating Screw for 44001.....
466H	23957	Shuttle (inside) Tension Regulating Screw for 16206.....
466H	23957	Shuttle (outside) Tension Regulating Screw for 16208 and 16209.....
600C	22723	Tension Screw Stud for 16202.....
634D	23960	Roller Screw for 1875.....
637C	23955	Tension Screw Stud for 33929.....
652D	23954	Roller Screw for 1841, 1868 and 1923....
688J	23955	Pressure Regulating Thumb Screw for 18-36 Machine.....
691D	23960	Throat Plate Screw for 18-36 Machine (2)
725J	22725	Cloth Plate Slide Spring Screw for 6479 and 6717 (2).....
725J	23951	Shuttle Race Cap Latch Screw for 6471 (2).....
738D	23957	Shuttle Race Screw for 18-36 Machine (2)
802D	23964	Lifting Lever Hinge Screw for 16044, 16054 and 16155.....
808F	22723	Needle Clamp Screw for 4303.....
813D	23957	Shuttle Race Hinge Screw, for 1/32 in. to 1/8 in. gauges, for 16166 and 16238.

NUMERICAL LIST OF PARTS

No.	Plate	Name
814D	23958	Shuttle Race Hinge Screw, for 9/64 in. to 11/64 in. gauges, for 16166.....
815D	23958	Shuttle Race Hinge Screw, for 3/16 in. to 1/4 in. gauges, for 16166.....
818D	22723	Feed Regulator Thumb Screw.....
921E	23955	Presser Bar Screw Bushing for 18-36 Machine.....
969C	23956	Oscillating Shaft Crank Slide Block Screw Stud for 19390.....
1019C	23955	Presser Bar Stop Collar Set Screw for 16148.....
1107C	22725	Cloth Plate Bracket Set Screw for 16143.
1253AL	22723	Tension Releaser Collar Set Screw for 16240 (2).....
1261D	23960	Roller Screw for 1958.....
1518J	22724	Oscillating Rock Shaft Hinge Pin Nut for 16212.....
1518J	22723	Crank Connecting Rod Hinge Screw Nut....
1518J	22723	Feed Connecting Link Hinge Screw Nut....
1518J	22723	" Forked Connection Hinge Screw Nut..
1518J	22723	Needle Bar Connecting Link Hinge Screw Nut for 16220.....
1518J	23956	Oscillating Shaft Crank Slide Block Screw Stud Nut for 16116.....
1528J	23954	Roller Screw Nut for 1839, 1841, 1868, 1869, 1875, 1897, 1898, 1923, 1958, 51832, 51834 and 51841.....
1547J	23954	Roller Arm Adjusting Screw Nut for 15446
1547J	23954	" " Screw Center Nut for 15444 (2).....
1547J	22723	Thread Take-up Lever Roller and Screw Stud Nut for 16041.....
1549J	23954	Roller Arm Lock Spring Screw Nut for 2196, 2197, 16014, 16017, 16071, 16082, 16099, 16100, 16225, 16226, 16228 and 16233 to 16236.....
1560C	22723	Tension Regulating Thumb Nut for 16202 and 33929.....
1562J	23961	Bobbin Winder Tension Regulating Thumb Nut for 27308.....
1620J	23961	Bobbin Winder Frame Hinge Screw Nut for 16272 and 150868.....
1766C	23960	Roller Ball Retaining Nut for 51832, 51834 and 51841.....
1813	22724	Oscillating Shaft Crank Roller and Stud for 6024.....
1819	23955	Tension Take-up Lever Roller and Stud for 6704.....
1839	23954	Roller, 1 1/4 in. diam., 9/64 in. face, coarse, with 386D and 1528J, for 16099.....

NUMERICAL LIST OF PARTS

No.	Plate	Name
1841	23954	Roller, 7/8 in. diam., 9/64 in. face, fine, with 652D and 1528J, for 2197.
1868	23954	Roller, 7/8 in. diam., 9/64 in. face, coarse, with 652D and 1528J, for 2196.....
1869	23954	Roller, 1 1/4 in. diam., 9/64 in. face, fine, with 386D and 1528J, for 16100
1875	23960	Roller, 1 1/2 in. diam., 7/32 in. face, coarse, with 634D and 1528J, for 16014 and 16017.....
1897	23954	Roller, 1 1/4 in. diam., 3/16 in. face, coarse, with 386D and 1528J, for 16225.....
1898	23967	Roller, 1 1/4 in. diam., 3/16 in. face, fine, with 386D and 1528J, for 16226
1915	22723	Thread Take-up Lever Roller and Screw Stud for 16041.....
1923	23967	Roller, 1 1/4 in. diam., 1/8 in. face, coarse, with 652D and 1528J, for 16228.....
1958	23960	Roller, 1 1/2 in. diam., 3/16 in. face, coarse, with 1261D and 1528J, for 16071 and 16082.....
2020	23953	Clamp Stop Motion Clamp Washer for 3022.
2022	-----	" " " Flanged Bushing Pin....
2049	22724	Shuttle Driver and Feed Lifting Cam Pin.
2070	22723	Presser Bar Spring Washer for 18-35 Machine.....
2073	23951	Shuttle Bobbin for 6028.....
2076	23951	" Cover Hinge Pin for 6028.....
2076	23957	" (inside) Cover Hinge Pin for 16206
2076	23957	" (outside) Cover Hinge Pin for 16208 and 16209.....
2078	23951	Shuttle Delivery Eye Thread Guard for 44001.....
2078	23957	Shuttle (inside) Delivery Eye Thread Guard for 16206.....
2080	23951	Shuttle Delivery Eye Thread Guard Rivet for 44001.....
2080	23957	Shuttle (inside) Delivery Eye Thread Guard Rivet for 16206.....
2080	23957	Shuttle (outside) Delivery Eye Thread Guard Rivet for 16208 and 16209.....
2082	23951	Shuttle Main Spring for 6058.....
2084	-----	" " " Steady Pin for 6058.
2084	-----	" (inside) Main Spring steady Pin for 3235.....
2084	-----	Shuttle (outside) Main Spring Steady Pin for 3232 and 3383.....
2086	23951	Shuttle Tension Spring for 44001.....

NUMERICAL LIST OF PARTS

No.	Plate	Name
2086	23957	Shuttle (inside) Tension Spring for 16206.....
2090	23951	Shuttle Tension Spring Plate for 44001..
2090	23957	" (inside) Tension Spring Plate for 16206.....
2102	22723	Tension Disc for 16137 and 16204.....
2103	22723	" Spring for 16137 and 16204.....
2106	23961	Bobbin Winder Tension Thread Guide for 27308.....
2111	22723	Thread Retainer Guide complete for 18-35 Machine, Nos. 2112, 2114 and 2115...
2112	22723	Thread Retaining Disc with 2113, for 2111.....
2113	22723	Thread Retaining Disc Steady Pin for 2112.....
2114	22723	Thread Retaining Spring for 2111.....
2115	22723	" Stud for 2111.....
2180	23952	Presser Foot for 18-35 Machine.....
2196	23954	Roller Presser complete, 7/8 in. diam., 9/64 in. face, coarse roller, for 18-35 Machine, Nos. 176J, 1549J, 1868, 2203, 2205, 2206, 15446 and two 15444..
2197	23954	Roller Presser complete, 7/8 in. diam., 9/64 in. face, fine roller, for 18-35 Machine, Nos. 176J, 1549J, 1841, 2203, 2205, 2206, 15446 and two 15444..
2203	23954	Roller Arm for 2196 and 2197.....
2205	23954	" " Lock Spring for 2196, 2197, 16099, 16100, 16225, 16226, 16228, 16233 and 16236.....
2206	23954	Roller Arm Bracket for 2196 and 2197....
2210	23957	Shuttle (inside) Bobbin for 16206.....
2210	23957	" (outside) Bobbin for 16208 and 16209.....
2211	23951	Shuttle Bobbin Retaining Spring for 6058
2212	23951	" " " Rivet for 6058 (2).....
2212	23957	Shuttle (inside) Bobbin Retaining Spring Rivet for 3235 (2).....
2212	23957	Shuttle (outside) Bobbin Retaining Spring Rivet for 3232 and 3383 (2).
2273	-----	Needle Clamp Pin for 16276 and 16277....
2410	23955	Tension Take-up Roller for 18-36 Machine
2411	23955	" " Stud for 18-36 Machine.....
2413	23955	Tension Thread Eyelet (double) for 18-36 Machine.....
2415	23968	Arm Spool Bracket for 15063.....
2455	23961	Bobbin Winder Tension Disc for 27308 (2)
2764	23964	Rock Shaft Hanger (back) with two wood screws 1 in. No. 10, for 16129.....
2766	23964	Rock Shaft Knee Arm Hub with 356C, for 16647.....

NUMERICAL LIST OF PARTS

No.	Plate	Name
2767	23964	Rock Shaft Knee Plate with 356C, for 16647.....
2770	23964	Rock Shaft Stop Dog with 140219C, for 16129 (2).....
3005	22723	Arm Shaft Bushing.....
3012	22723	Thread Take-up Cam Pin.....
3022	23953	Clamp Stop Motion complete, Nos. 248K, 256J, 2020 and 4933.....
3037	22723	Feed Forked Connection.....
3045	22723	Needle Bar Connecting Link for 16220....
3054	22723	Presser Bar for 18-35 Machine.....
3214	23955	Needle Bar Guide with 400C and 453AL, for 18-36 Machine.....
3230	23957	Shuttle (inside) Bobbin Retaining Spring for 3235.....
3230	23957	Shuttle (outside) Bobbin Retaining Spring for 3232 and 3383.....
3232	23957	Shuttle (outside) Body with 398E, 2084, 3230, 3239 and two 2212, for 16209..
3235	23957	Shuttle (inside) Body with 398E, 2084, 3230, 3240 and two 2212, for 16206..
3238	23957	Shuttle (outside) Delivery Eye Thread Guard for 16208 and 16209.....
3239	23957	Shuttle (outside) Main Spring for 3232 and 3383.....
3240	23957	Shuttle (inside) Main Spring for 3235...
3241	23957	" (outside) Tension Spring for 16208 and 16209.....
3242	23957	Shuttle (outside) Tension Spring Plate for 16208 and 16209.....
3286	22725	Cloth Plate Slide Spring for 6479 and 6717.....
3383	23958	Shuttle (outside) Body with 398E, 2084, 3230, 3239 and two 2212, for 16208..
4282	23954	Roller Arm Bracket for 16099, 16100, 16225, 16226, 16228, 16233 and 16236
4288	23953	Arm Side Cover (back).....
4292	22723	Crank Connecting Rod with two 145E.....
4302	22723	Needle Bar Thread Guide for 18-35 Machine.....
4303	22723	Needle Clamp with 808F, for 18-35 Machine.....
4345	23955	Needle Clamp with two 336F, for 1/32 in. to 5/64 in. gauges, for 16276.....
4784	22724	Oscillating Rock Shaft Oil Pad for 6461 and 16112.....
4785	23960	Roller Arm Bracket for 16014, 16082 and 16234.....
4822	23963	Wrench for 1528, 1547 and 1549 (Attachments and Accessories).....

NUMERICAL LIST OF PARTS

No.	Plate	Name
4879	23966	Chain Connecting Link for 4885.....
4881	23966	Treadle for 4885.....
4882	23966	" Shaft for 4885.....
4883	23966	" Spring for 4885.....
4884	23966	" Stand for 4885.....
4885	23966	Treadle complete for 16054, Nos. 4879, 4881 to 4884 and two wood screws 1 in. No. 16.....
4933	23953	Clamp Stop Motion Flanged Bushing with two 462AL, for 3022.....
5459	22723	Presser Bar Spring (light) .047 in.wire, for 18-35 Machine.....
6018	22724	Feed Rock Shaft Crank with 207F.....
6024	22724	Oscillating Shaft Crank with 1813 and two 462AL, for 18-35 Machine.....
6028	23951	Shuttle (high point) complete for 18-35 Machine, Nos. 2073, 2076, 6058 and 4400L.....
6055	23963	Machine Bolt Nut Washer (Attachments and Accessories).....
6058	23951	Shuttle Body with 398E, 2082, 2084, 2211 and two 2212, for 6028.....
6337	23964	Rock Shaft Lifting Bracket with two 356C, for 16129.....
6338	23964	Rock Shaft Lifting Bracket Hook for 16129.....
6439	23966	Chain, 36 in. to 45 in., with 56864 and 56865, for 16054.....
Note: When ordering No. 6439, give length required.		
6458	22724	Feed Dog Carrier.....
6459	22723	" Regulator.....
6461	22724	Oscillating Rock Shaft with 4784, for 16176.....
6464	22723	Presser Bar Lifter.....
6465	22723	" " Washer.....
6466	-----	" " Spring (medium) .055 in. wire, for 18-35 Machine.....
6467	-----	Presser Bar Spring (heavy) .063 in.wire, for 18-35 Machine.....
6469	22723	Presser Bar Lifting Bracket Guide.....
6471	23951	Shuttle Race Cap complete for 16227, Nos. 6472, 6800 and two 725J.....
6472	23951	Shuttle Race Cap Latch for 6471.....
6477	22723	Thread Take-up Spring Regulator Plate...
6478	22725	Cloth Plate with Bracket complete for 18-35 Machine, Nos. 6479, 16143 and two 389F.....
6479	22725	Cloth Plate complete for 6478, Nos. 3286, 16032, 16034 and two 725J.....
6487	22723	Needle Bar Connecting Stud with 155C, for 16220.....

NUMERICAL LIST OF PARTS

No.	Plate	Name
6489	22724	Oscillating Rock Shaft Hinge Pin for 16212.....
6492	23952	Throat Plate (fluted) large needle hole, for 16078, for 18-35 Machine.....
6524	23955	Needle Clamp with two 50014F, for 3/32 in. to 1/4 in. gauges, for 16277....
6535	23960	Roller Arm for 16014 and 16082.....
6600	23955	Tension Releaser for 18-36 Machine.....
6602	23955	Thread Take-up Spring Thread Guard and Thread Eyelet for 18-36 Machine.....
6603	23955	Tension Take-up Spring for 18-36 Machine
6677	23960	Feed Dog, 8 teeth (14 teeth to the inch) 3/32 in. to 1/4 in. gauges, for 16153, for 18-36 Machine.....
6702	23959	Cloth Plate with Bracket complete for 18-36 Machine, Nos. 6717, 6719 and two 389F.....
6703	23964	Pitman, length 14 1/8 in., for 16044.....
6704	23955	Tension Take-up Lever with 1819, for 16181.....
6709	23957	Shuttle Race Lock Pin for 6746 and 16239
Note: When ordering No. 6709, state gauge of Shuttle Race for which it is required.		
6716	23959	Cloth Plate for 6717.....
6717	23959	Cloth Plate complete for 6702, Nos. 3286, 6716, 6718 and two 725J.....
6718	23959	Cloth Plate Slide for 6717.....
6719	23959	" " Bracket with 345C, for 6702.
6746	23958	Shuttle Race complete for 3/32 in. to 1/4 in. gauges, for 18-36 Machine, Nos. 6709, 6758, 16166 and two 102J.
6758	23957	Shuttle Race Lock Pin Spring for 6746 and 16239.....
6768	22723	Thread Take-up Spring for 18-35 Machine.
6800	23951	Shuttle Race Cap for 6471.....
7124	23964	Rock Shaft for 16129.....
7393	22723	Tension Releaser Collar Pin for 16240...
7556	23960	Roller Arm Lock Spring for 16014, 16017, 16071, 16082, 16234 and 16235.....
7898	23965	Pitman, length 19 in., for 16155.....
8879	22723	Arm Spool Pin Washer (cloth) for 18-35 Machine.....
8908	23963	Wrench for 1620 (Attachments and Ac- cessories).....
8909	23963	Wrench for 1513 and 1518 (Attachments and Accessories).....
10141	23961	Bobbin Winder Tension Spring for 27308..
11170	23955	Presser Bar Spring Washer for 18-36 Ma- chine.....
11241	23968	Arm Spool Bracket Spool Pin Washer (cloth) for 18-36 Machine (2).....

NUMERICAL LIST OF PARTS

No.	Plate	Name
11241	23961	Bobbin Winder Spool Washer (cloth) for 27308.....
12424	23956	Oscillating Shaft Crank Slide Block Cap Screw Washer for 19390.....
15063	23968	Arm Spool Bracket 2415 with two 52239, for 18-36 Machine.....
*15404	-----	Trade Mark for 16291 and 16295.....
15405	-----	" " Rivet for 16291 and 16295 (2)
15444	-----	Roller Arm Screw Center 316F with 1547J, for 2196, 2197, 16014, 16017, 16071, 16082, 16099, 16100, 16225, 16226, 16228 and 16233 to 16236 (2).....
15446	-----	Roller Arm Adjusting Screw 440F with 1547J, for 2196, 2197, 16014, 16017, 16071, 16082, 16099, 16100, 16225, 16226, 16228 and 16233 to 16236.....
16010	23960	Roller Needle Guard (flat) for 16014....
16013	23960	" " (round) for 16014....
16014	23960	Roller Presser complete, 1 1/2 in. diam., 7/32 in. face, coarse roller, for 1/32 in. to 1/16 in. gauges, for 18-36 Machine, Nos. 171F, 176J, 207F, 1549J, 1875, 4785, 6535, 7556, 15446, 16010, 16013 and two 15444.....
16015	23960	Roller Arm for 16017 and 16071.....
16016	23960	" Needle Guard (round) for 16017, 16071 and 16235.....
16017	23960	Roller Presser complete, 1 1/2 in.diam., 7/32 in. face, coarse roller, for 3/32 in. to 1/4 in. gauges, for 18-36 Machine, Nos. 171F, 176J, 1549J, 1875, 7556, 15446, 16015, 16016, 19200 and two 15444.....
16018	23960	Feed Dog, 8 teeth (14 teeth to the inch) for 1/32 in. to 5/64 in. gauges, for 16153, for 18-36 Machine.....
16022	22723	Tension Thread Guard for 18-35 Machine..
16031	23962	Machine Base with four each 121E and wood screws 1 1/4 in. No. 12.....
16032	22725	Cloth Plate for 6479.....
16034	22725	" " Slide for 6479.....
16036	23953	Cylinder Side Cover.....
16037	22724	Feed Rock Shaft for 18-35 Machine.....
16039	22724	Oscillating Shaft for 18-35 Machine....
16040	23952	Throat Plate (fluted) for 16078, for 18-35 Machine.....
16041	22723	Thread Take-up Lever with 1547J and 1915, for 16179.....
16042	23964	Lifting Lever for 16044, 16054 and 16155
16043	23964	" " Spring for 16044, 16054 and 16155.....

NUMERICAL LIST OF PARTS

No.	Plate	Name
16044	23964	Knee Lifter complete (Power Table or Stand) Nos. 802D, 6703, 16042, 16043 and 16129.....
16045	22724	Cylinder Oil Tube for oiling Oscillating Shaft.....
16054	23966	Foot Lifter complete, Nos. 802D, 4885, 6439, 16042 and 16043.....
16071	23960	Roller Presser complete, 1 1/2 in.diam., 3/16 in. face, coarse roller, for 3/32 in. to 1/4 in. gauges, for 18-36 Machine, Nos. 171F, 176J, 1549J, 1958, 7556, 15446, 16015, 16016, 19200 and two 15444.....
16075	23956	Feed Rock Shaft for 18-36 Machine.....
16077	23962	Drip Pan.....
16078	23952	Feed Dog, 10 teeth (16 teeth to the inch) for 6492, 16040, 16096, 16097 and 16131, for 18-35 Machine.....
16080	23960	Roller Needle Guard (flat) for 16082 and 16234.....
16081	23960	Roller Needle Guard (round) for 16082 and 16234.....
16082	23960	Roller Presser complete, 1 1/2 in.diam., 3/16 in. face, coarse roller, for 1/32 in. to 5/64 in. gauges, for 18-36 Machine, Nos. 171F, 176J, 207F, 1549J, 1958, 4785, 6535, 7556, 15446, 16080, 16081 and two 15444.....
16095	23952	Throat Plate (fluted) needle hole drilled for No. 1 needle to locate close to the side nearest the feedway, for 16107 and 16172, for 18-35 Machine.....
Note: No. 16095 is sent with the 18-35 Machine unless another Throat Plate is specified on order.		
16096	23952	Throat Plate (not fluted) needle hole drilled for No. 2 needle to locate close to the side nearest the feedway, for 16078, for 18-35 Machine...
16097	23952	Throat Plate (fluted) small needle hole, for 16078, for 18-35 Machine.....
16098	23954	Roller Arm for 16099, 16100, 16225, 16226 and 16228.....
16099	23954	Roller Presser complete, 1 1/4 in.diam., 9/64 in. face, coarse roller, for 18-35 Machine, Nos. 176J, 1549J, 1839, 2205, 4282, 15446, 16098 and two 15444.
16100	23954	Roller Presser complete, 1 1/4 in.diam., 9/64 in. face, fine roller, for 18-35 Machine, Nos. 176J, 1549J, 1869, 2205, 4282, 15446, 16098 and two 15444.

NUMERICAL LIST OF PARTS

No.	Plate	Name
27305	23961	Bobbin Winder Spindle for 16272 and 150868.....
27306	23961	Bobbin Winder Spool Pin for 27308.....
27307	23961	" " " Stand for 27308.....
27308	23961	Bobbin Winder Spool Stand complete for 16273 and 150869, Nos. 418E, 1562J, 2106, 10141, 11241, 27306, 27307 and two each 2455 and wood screws 1 in. No. 10.....
27321	23961	Bobbin Winder Frame for 16272 and 150868
27322	23961	" " " Spring for 16272 and 150868.....
27326	23961	Bobbin Winder Stop Latch for 16272 and 150868.....
27541	23961	Bobbin Winder Pulley for 16272.....
33929	-----	Tension Screw Stud 637C with 1560C, for 16137.....
44001	23951	Shuttle Cover with 112E, 466H, 2078, 2080, 2086 and 2090, for 6028.....
50014F	23955	Needle Set Screw for 6524 (2).....
50037F	23951	Shuttle Race Screw for 18-35 Machine (4)
50116K	22723	Tension Releaser Screw for 18-35 Machine
50356D	23961	Bobbin Winder Frame Hinge Screw for 16272 and 150868.....
50553C	23960	Roller Screw for 51832, 51834 and 51841.
51072E	23963	Machine Bolt with 51581E, to secure machine to table (Attachments and Accessories).....
51224W	23953	Arm Side Cover (back) Thumb Screw.....
51224W	23953	Cylinder Side Cover Thumb Screw.....
51581E	23963	Machine Bolt Nut for 51072E.....
51832	23967	Roller, 1 1/4 in. diam., 7/32 in. face, coarse (ball bearing) complete for 16233, Nos. 1528J, 1766C, 50553C and twenty-four 16232.....
51834	23960	Roller, 1 1/2 in. diam., 3/16 in. face, coarse (ball bearing) complete for 16234 and 16235, Nos. 1528J, 1766C, 50553C and twenty-four 16232.....
51841	23967	Roller, 1 1/4 in. diam., 5/32 in. face, coarse (ball bearing) complete for 16236, Nos. 1528J, 1766C, 50553C and twenty-four 16232.....
52165	22723	Feed Connecting Link.....
52239	23968	Arm Spool Bracket Spool Pin and Thread Eyelet for 15063 (2).....
52239	22723	Arm Spool Pin and Thread Eyelet for 18-35 Machine.....
56864	23966	Chain Hook (large) for 6439.....
56865	23966	" " (small) for 6439.....

NUMERICAL LIST OF PARTS

No.	Plate	Name
65118	22723	Feed Cam and Arm Shaft Counterbalance with 435AL, for 16293.....
120342	23963	Oiler (copper plated) with 120343 (Attachments and Accessories).....
120343	23963	Oiler Spout, 3 1/2 in. long, for 120342.
140219C	23964	Rock Shaft Stop Dog Set Screw for 2770 (2).....
150785	23961	Bobbin Winder Pulley for 150868.....
150868	23961	Bobbin Winder for 150869, Nos. 35D, 1620J, 16271, 27305, 27321, 27322, 27326, 50356D, 150785 and two wood screws 1 in. No. 7.....
150869	23961	Bobbin Winder (swinging automatic, left hand) complete for "V" belt, Nos. 27308 and 150868.....

Genuine Singer Needles should be used in Singer Machines. These Needles and their Containers are marked with the Company's Trade Mark "SIMANCO." 1

Needles in Containers marked "For Singer Machines" are not Singer made needles. 2

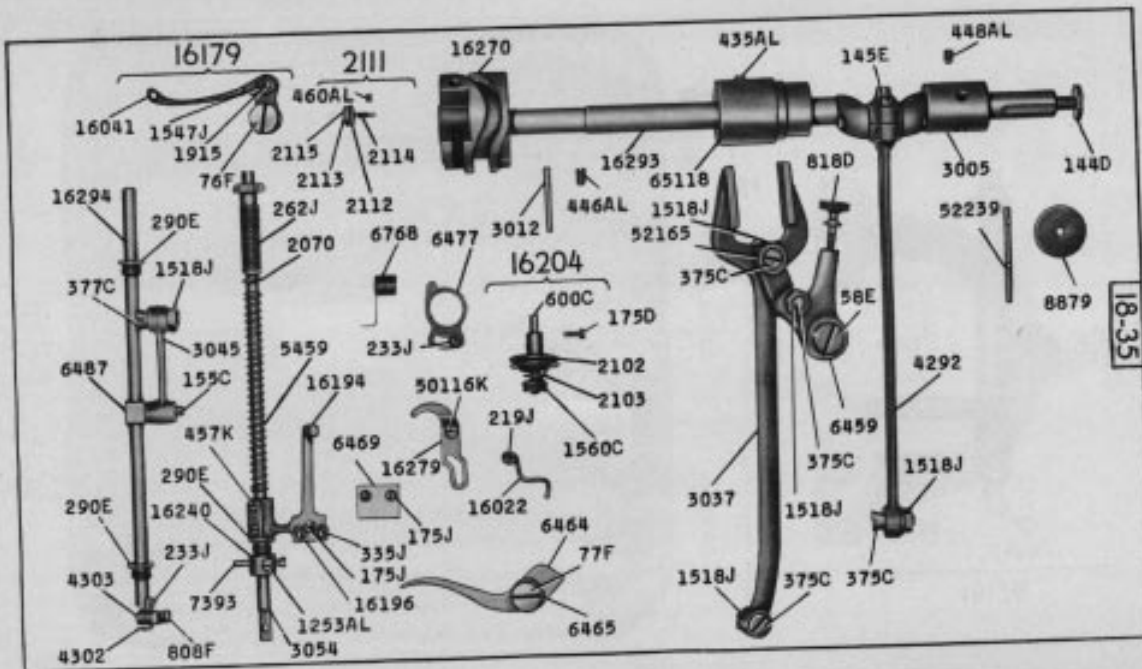

22723 - 1/3
 18-35

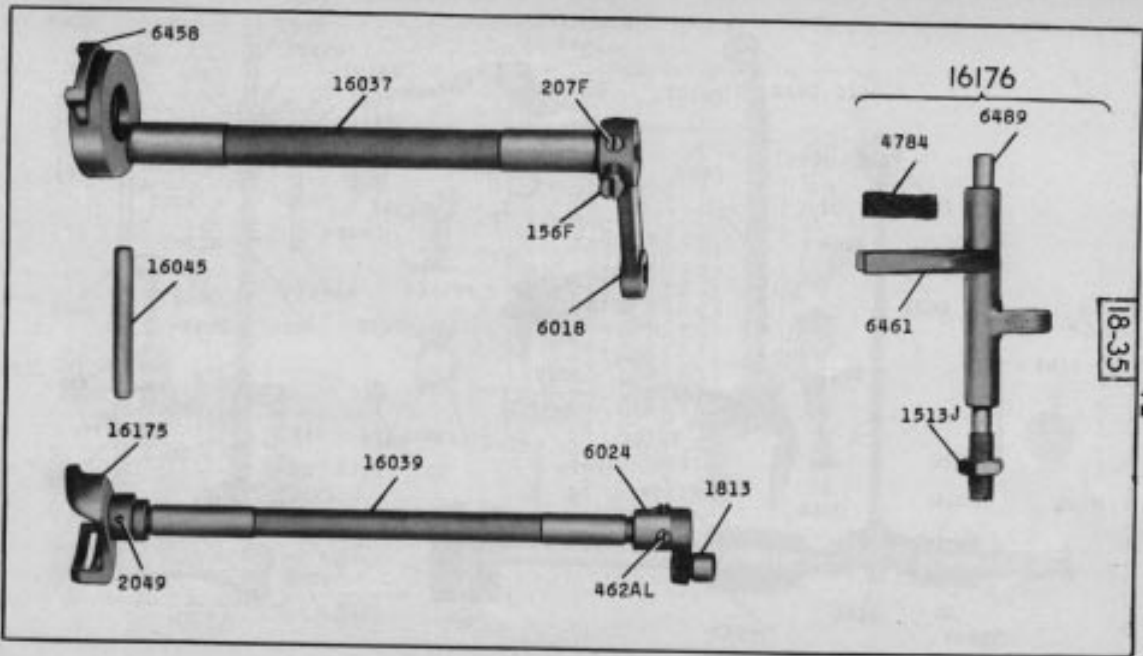

22724 - 1/2
18-35

22725 - 1/2

6478

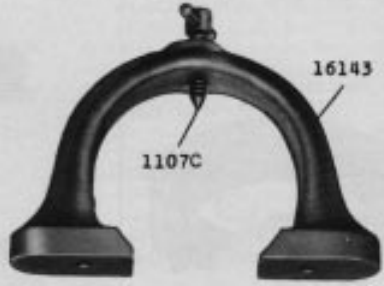

6479

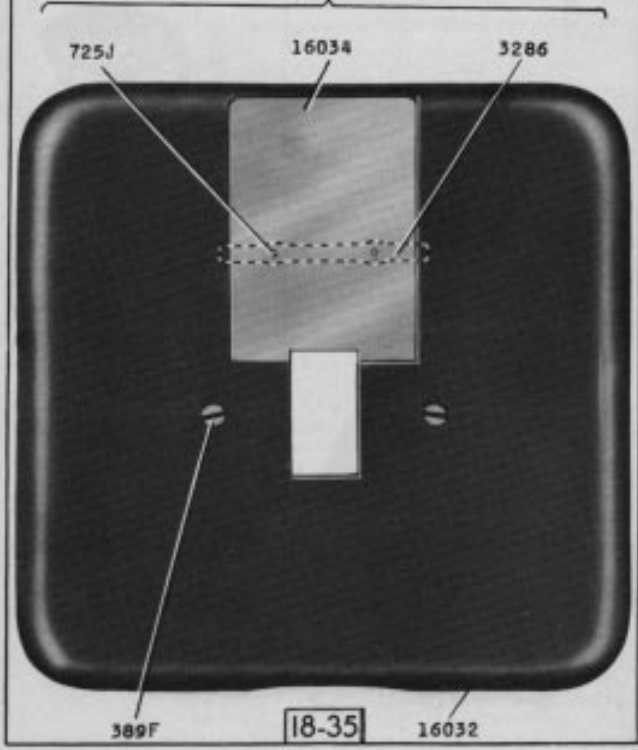

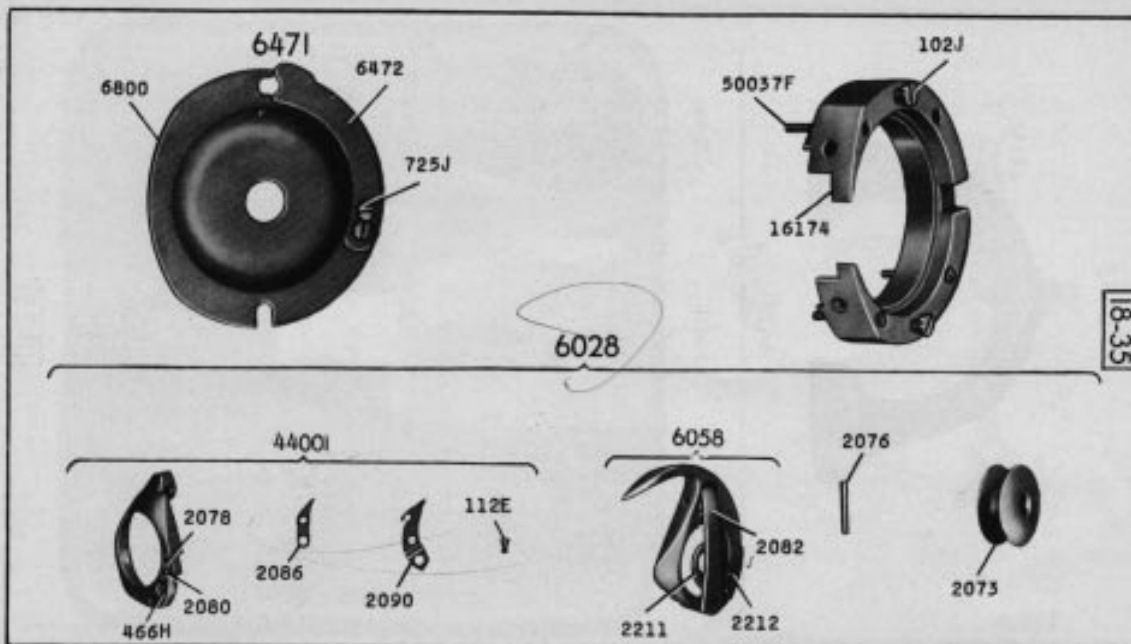

23951 - 2/3
18-35

23952 - 2/3

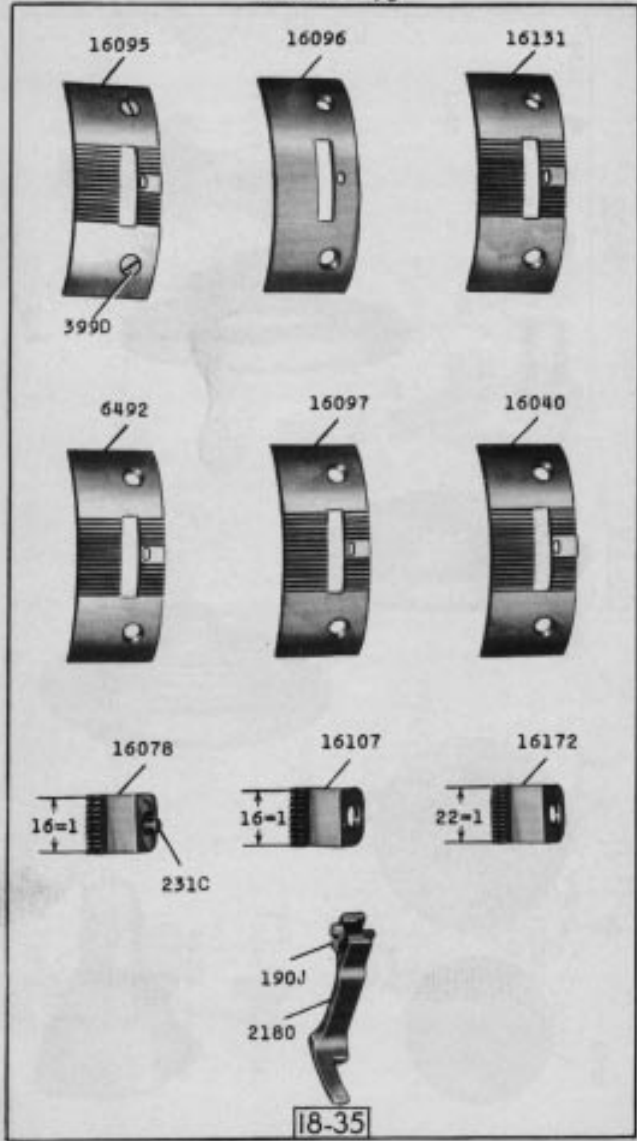

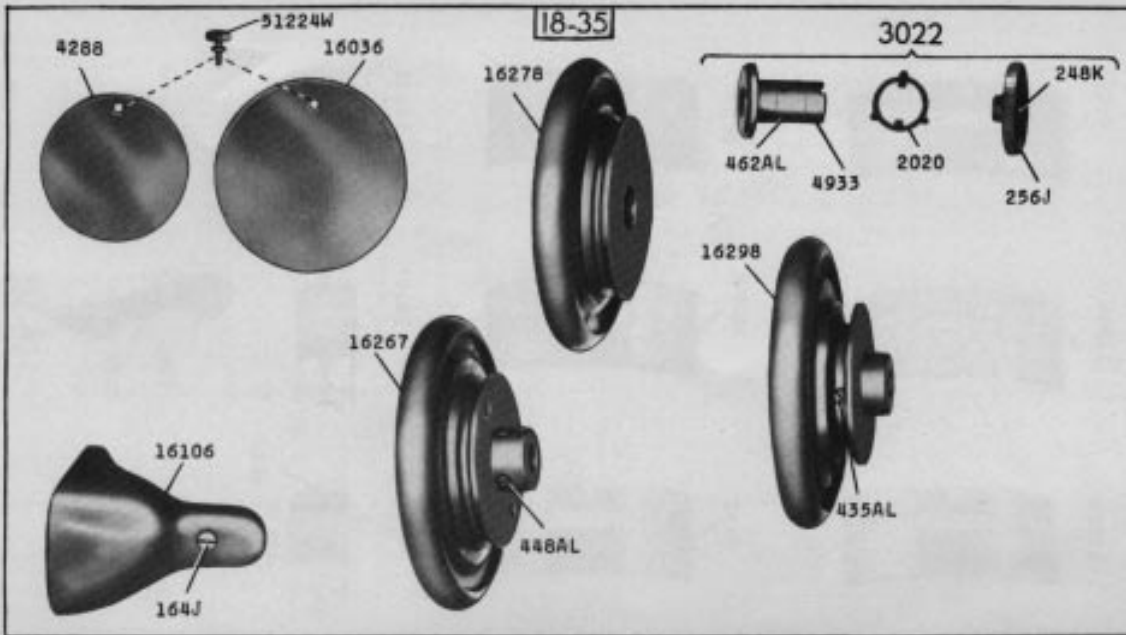

23953 - 1/3

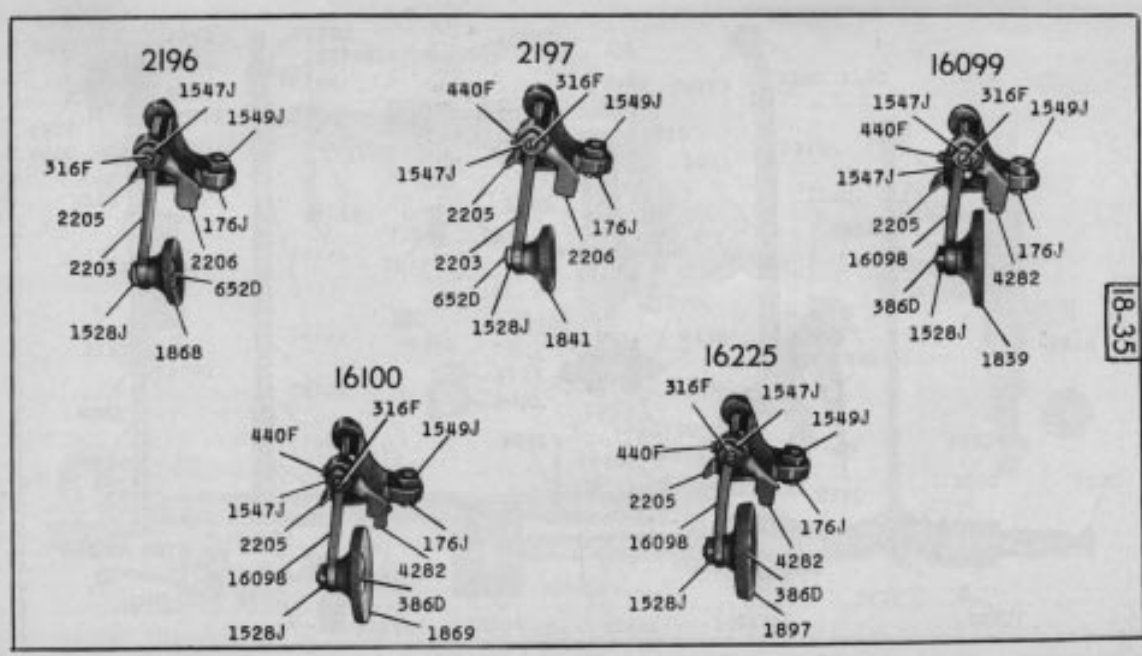

23954 - 1/2

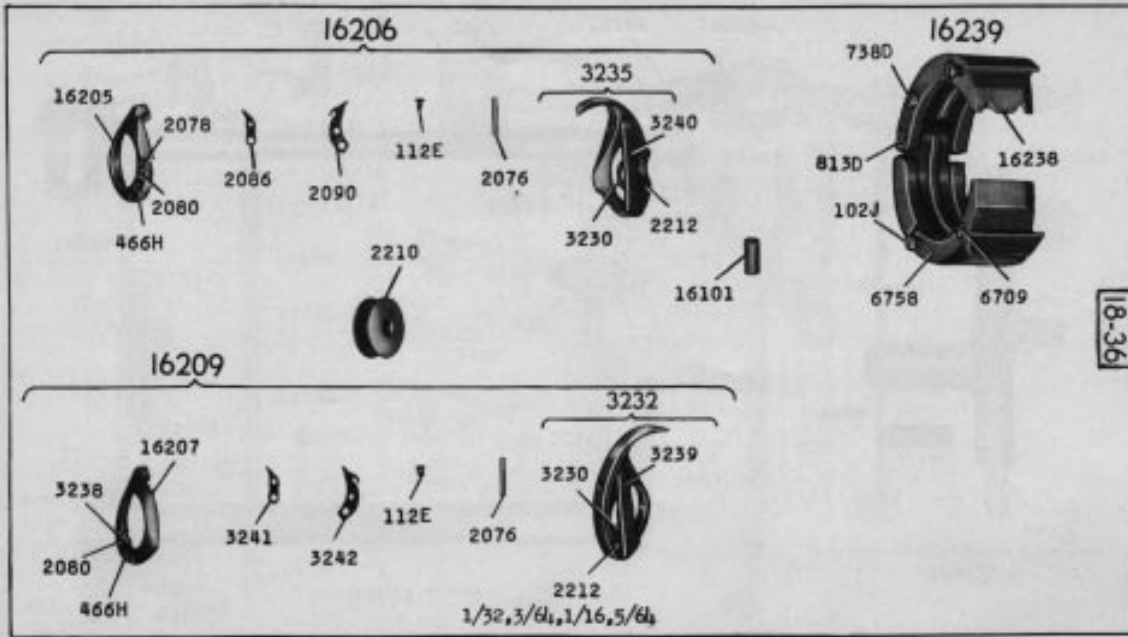

23957 - 1/2

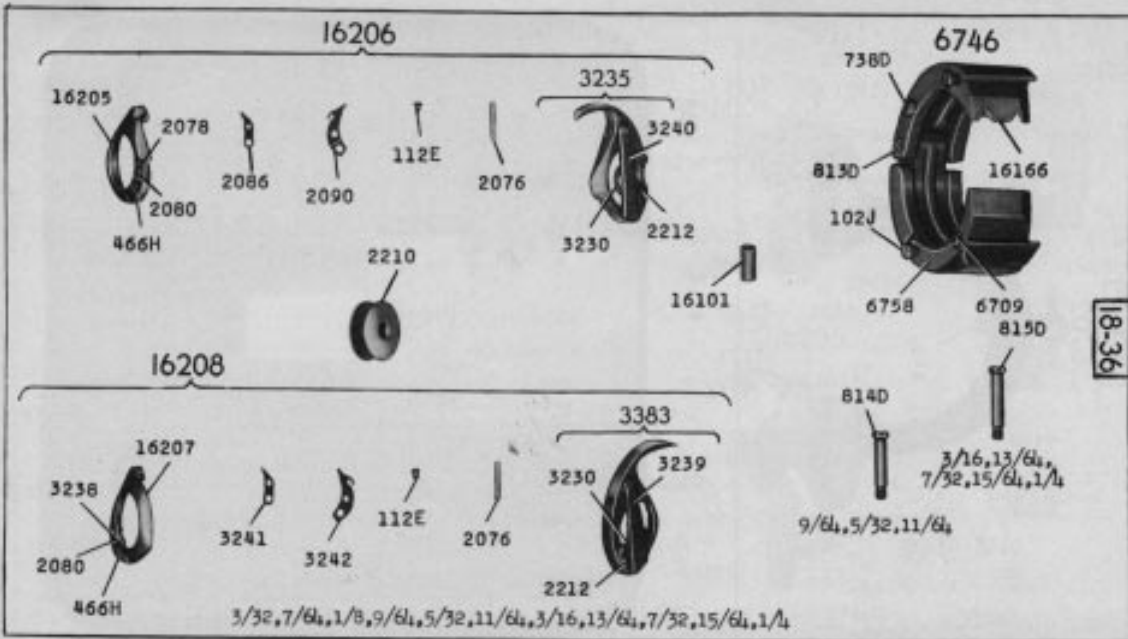

23958 - 1/2

23959 - 1/2

18-36

6702

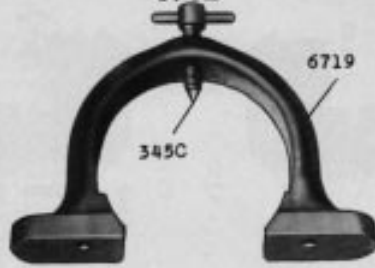

6717

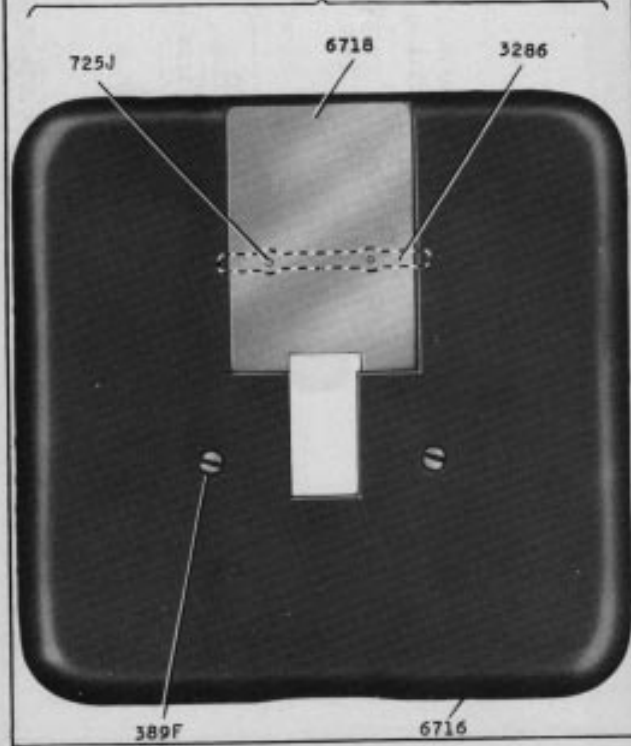

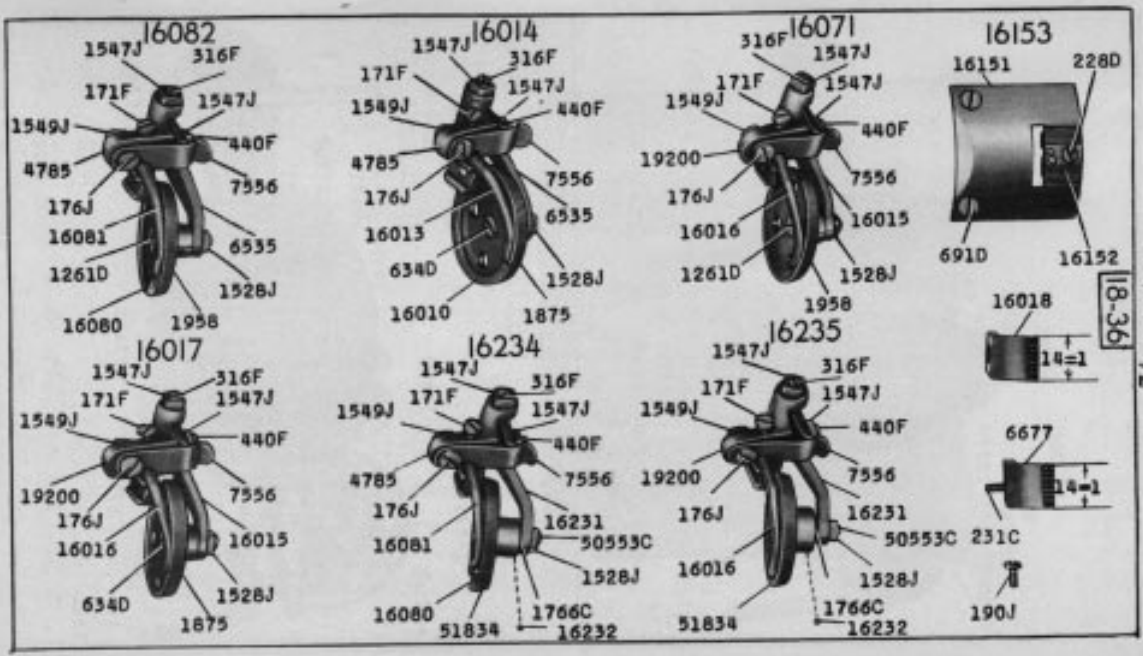

23960 - 1/2
18-36

23961 - 1/2

150869

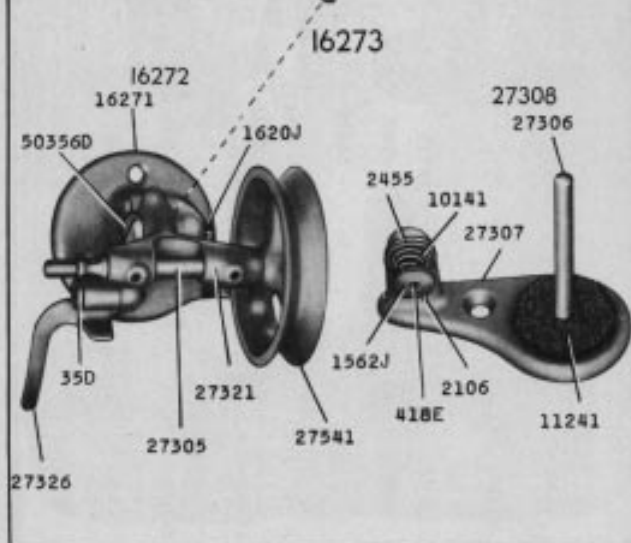
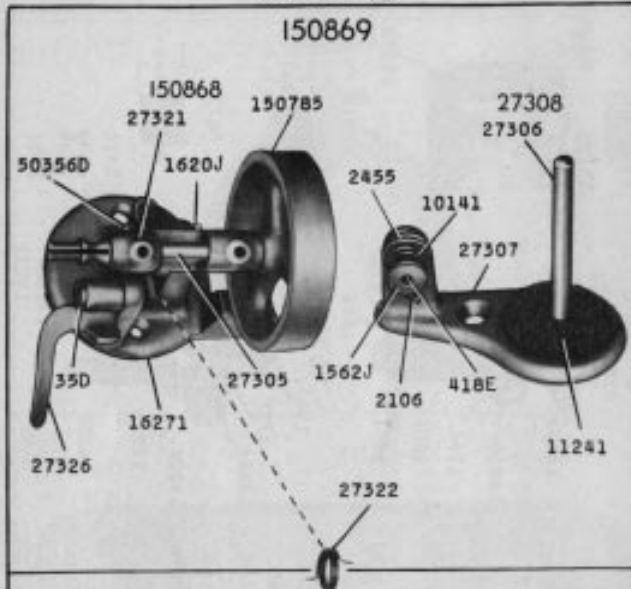

23962 - 1/3

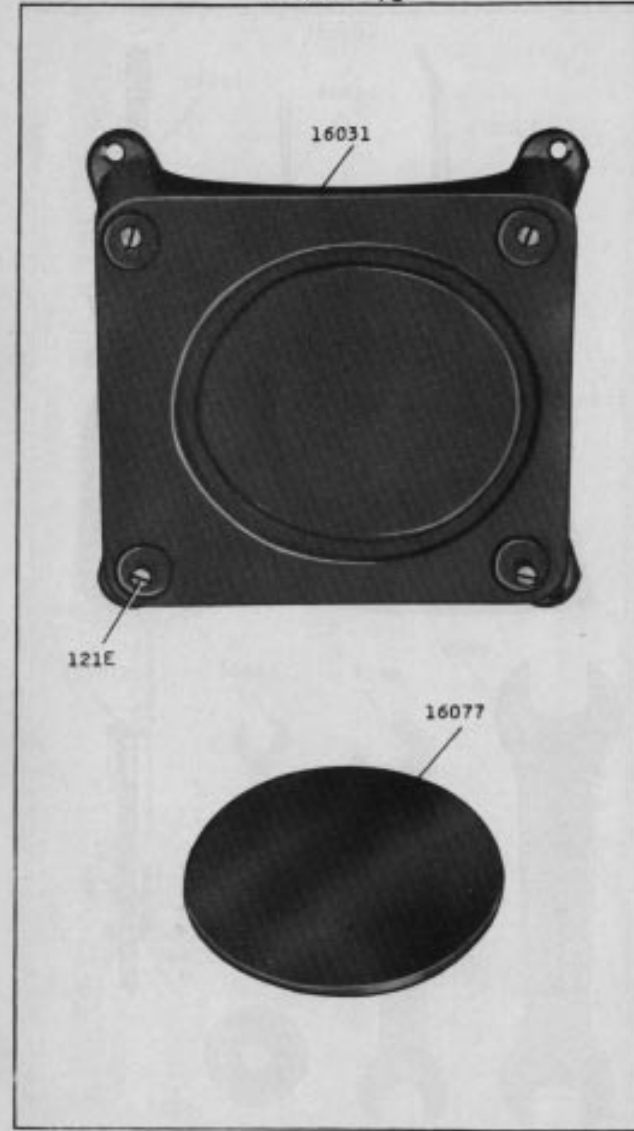

23963 - 2/3



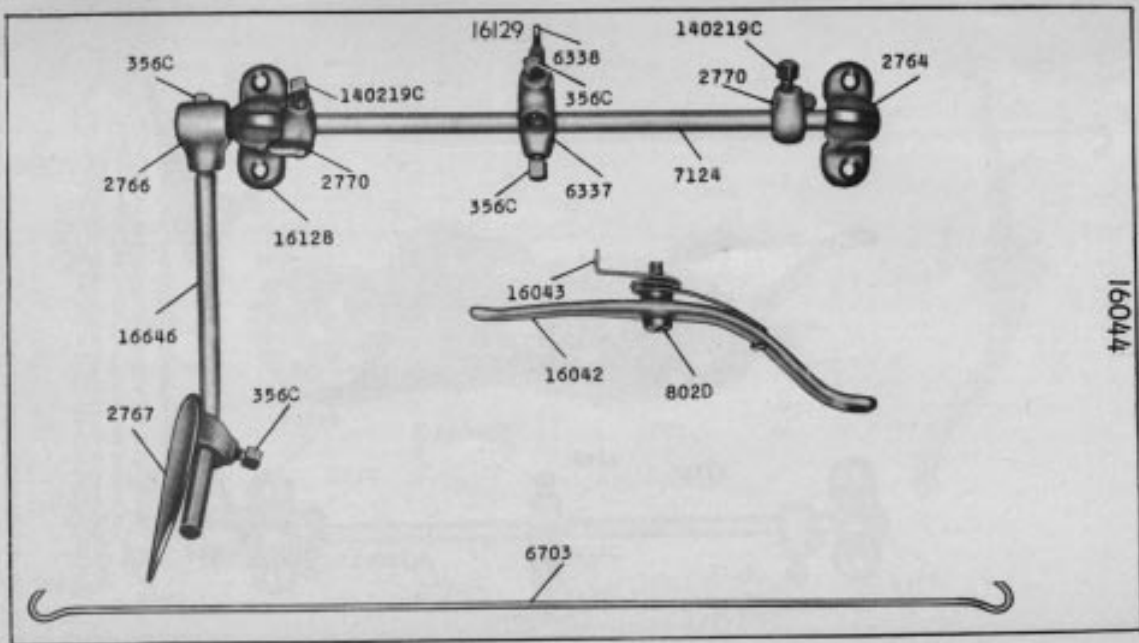

23964 - 1/3
16044

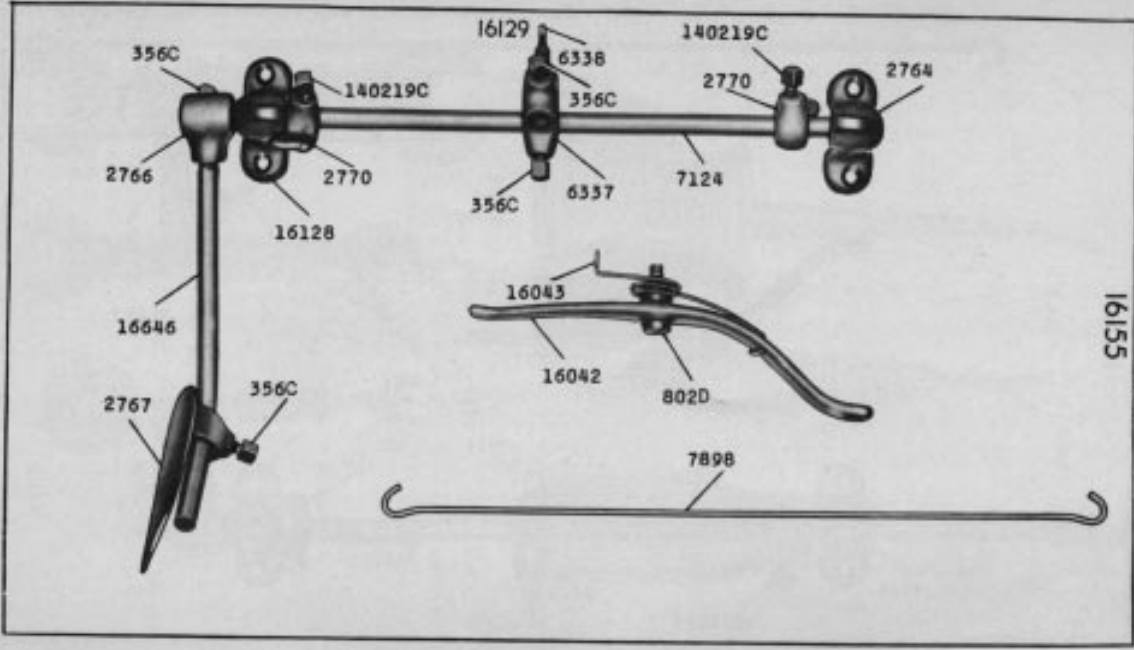

23965 - 1/3
16155

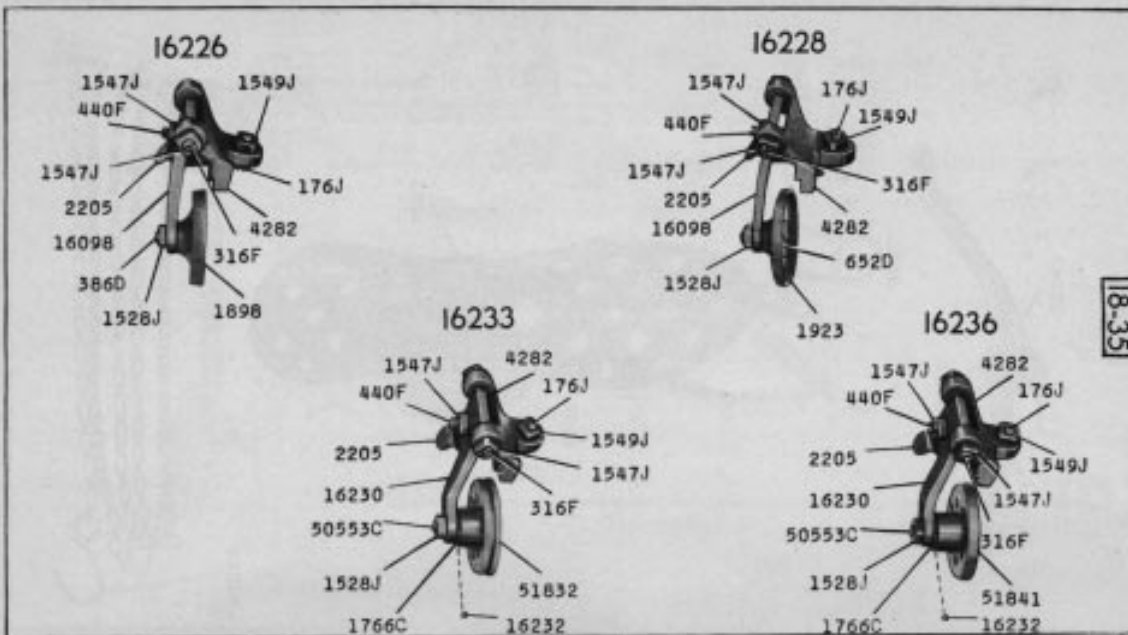

23967 - 1/2
18-35

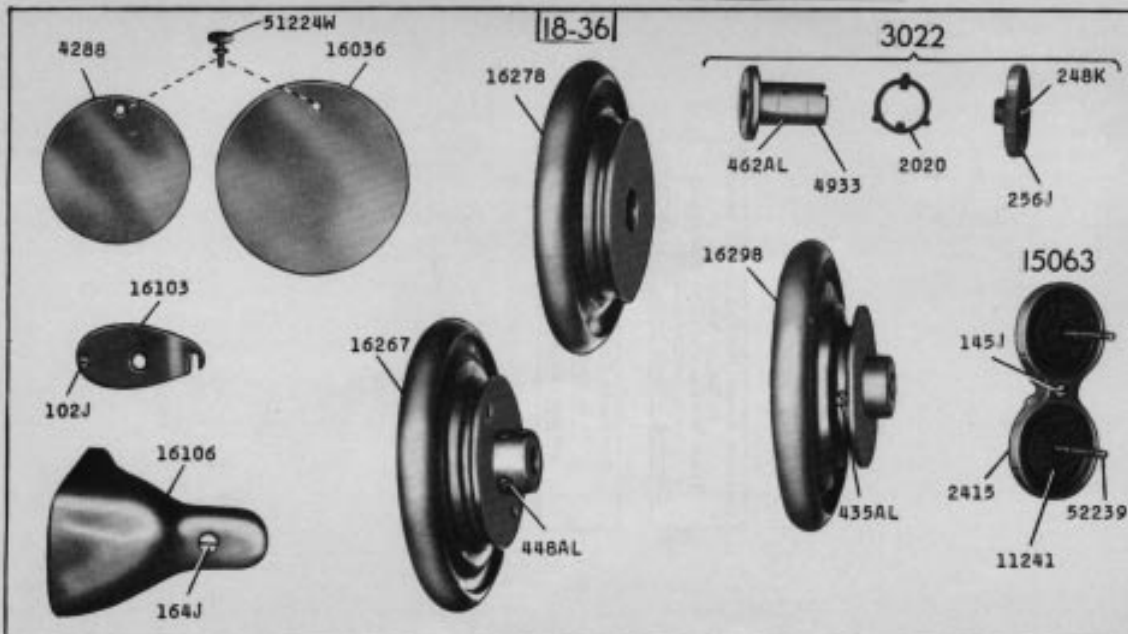

23968 - 1/3